

外表颜色 支持定制



镜光
(Chrome Polish)



砂光
(Brushed)



砂镍
(Brushed nickel)



白色
(White)



枪灰
(Gun metal)



钛金
(Gold)



拉丝黄铜
(Brushed brass)



PVD深铜色
(Brushed Copper)



玫瑰金
(Rose Gold)



黑色
(Black)

温馨提示 (TIPS) :

展示图为产品效果图, 因受印刷色彩、不同生产批次或环境光影响, 与实物或许有少许色差属于正常现象, 请以实物为准。

支持110/220V各式插头定制



澳规



中规



美规



欧规



英规

220V-240V 安全开关



触屏控温控温开关
定时1H - 8H | 温度调节40°C - 60°C



2H/4H 金属开关
55°C恒温 | 定时2H/4H



普遍圆型开关
一键开关 | 恒温55°C



无极旋钮开关
一键设定 | 温度随意调 | 8H智能开启

关于时间控制



WIFI控制



定时加热



智能控温



天猫精灵

智能定时 | 远程操控 | 一次设定 | 终身享用

304不锈钢电热毛巾架虽耗能低, 出于绿色环保理念, 毛巾架不需全天24小时开启



家用卫浴间



别墅卫浴间

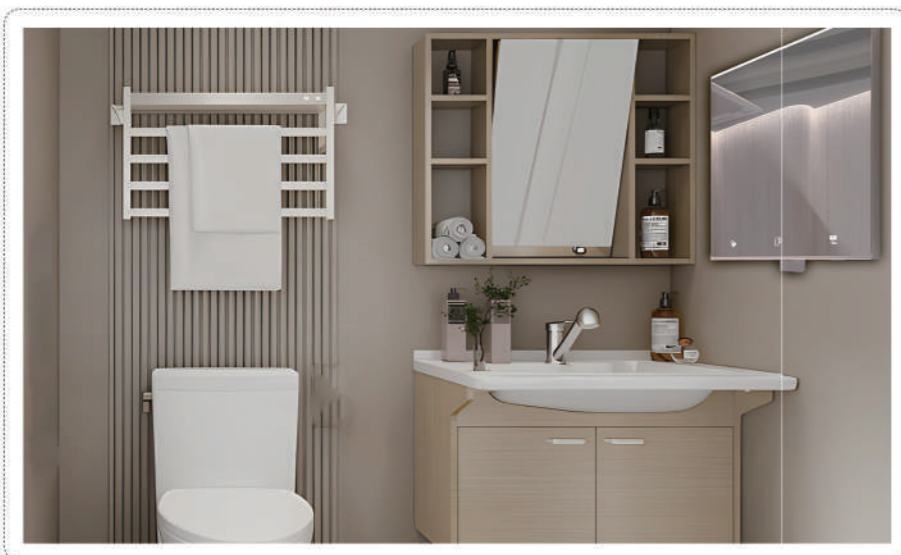

适老化卫生间

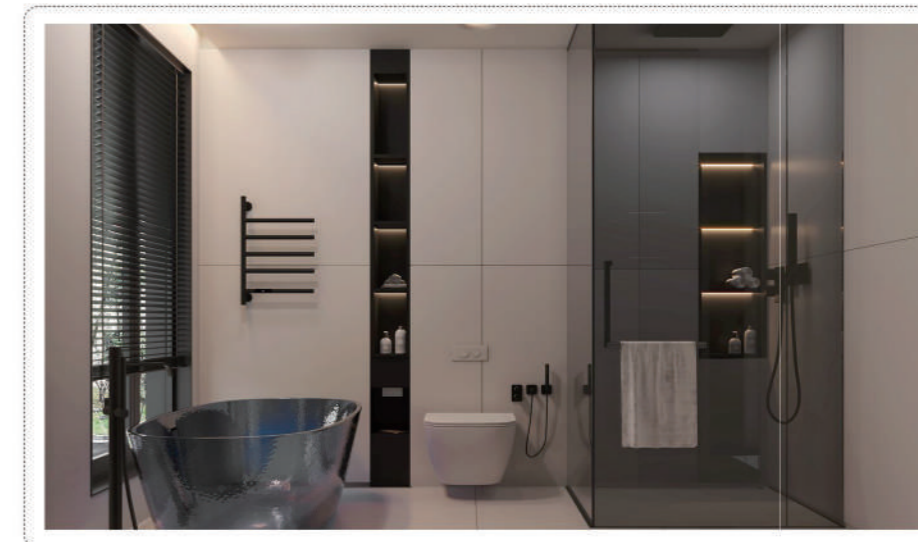

总统套房卫浴间

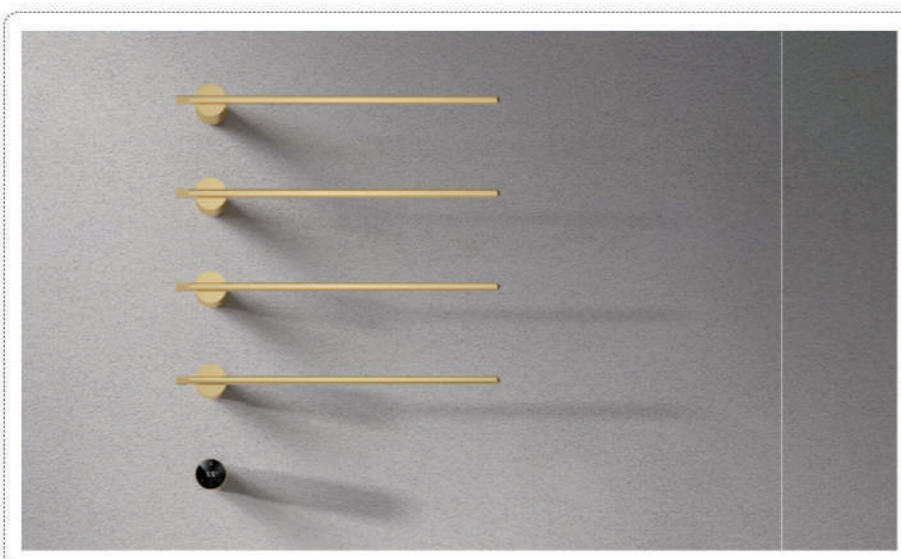

公共场所卫浴间

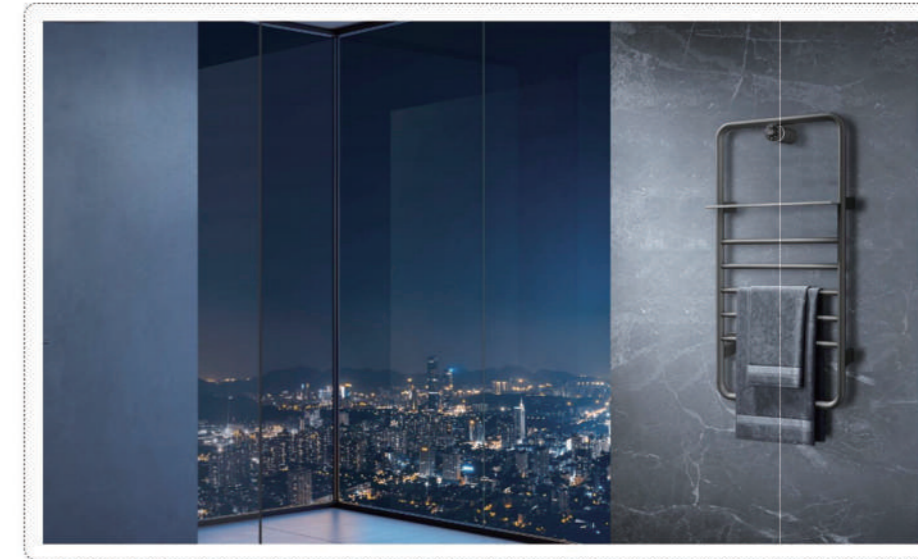

星级酒店卫浴间

智能产品
应用场景
SCENE DISPLAY
OEM/ODM

智能电热毛巾架-青枫系列



L-SR0003

管型 Tube Type : 圆管 (φ19.1x1.2)

尺寸 Size: 510*520*78 mm

开关 Switch: 触屏恒温时控1-9H

电压 Voltage: 12V/220-240V

功率 Rating: 30W

材质 Material: 304不锈钢

安装方式 Install: 暗装 (需接地线)

颜色 Colour : ● 镜光 ● 雅黑 ● 雅白 ● 拉丝枪灰 ● 拉丝黄铜

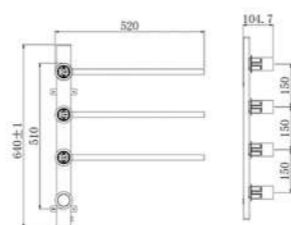

L-SR0004

管型 Tube Type : 圆管 (φ19.1x1.2)

尺寸 Size: 660*520*78 mm

开关 Switch: 触屏恒温时控1-9H

电压 Voltage: 12V/220-240V

功率 Rating: 40W

材质 Material: 304不锈钢

安装方式 Install: 暗装 (需接地线)

颜色 Colour : ● 镜光 ● 雅黑 ● 雅白 ● 拉丝枪灰 ● 拉丝黄铜

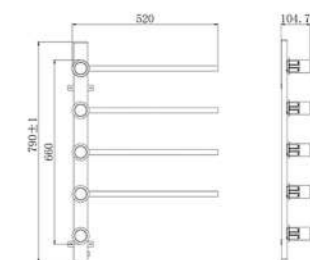

L-SR0005

管型 Tube Type : 圆管 (φ19.1x1.2)

尺寸 Size: 810*520*78 mm

开关 Switch: 触屏恒温时控1-9H

电压 Voltage: 12V/220-240V

功率 Rating: 55W

材质 Material: 304不锈钢

安装方式 Install: 暗装 (需接地线)

颜色 Colour : ● 镜光 ● 雅黑 ● 雅白 ● 拉丝枪灰 ● 拉丝黄铜

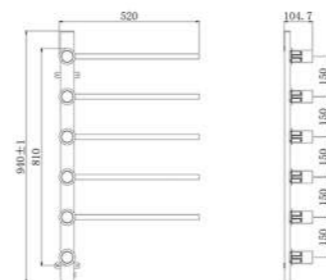

L-SR0200

管型 Tube Type: 圆管

尺寸 Size: 670*410*80 mm

开关 Switch: 触屏恒温时控1-8H

电压 Voltage: 220v

功率 Rating: 65w

材质 Material: 304不锈钢

安装方式 Install: 明装/暗装(需接地线)

颜色 colour: ● 镜光 ● 雅黑 ● 雅白 ● 拉丝枪灰 ● 拉丝黄铜

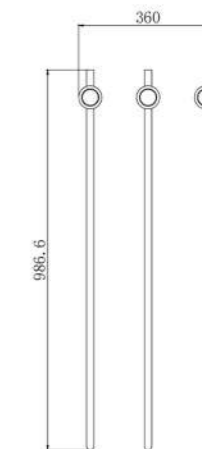

智能电热毛巾架-四季系列



F-CR04

管型 Tube Type : 圆管

尺寸 Size: 600*360*80 mm

开关 Switch: 触屏恒温时控1-8H

电压 Voltage: 220V 50Hz

功率 Rating: 45W

材质 Material: 304不锈钢

安装方式 Install: 明装/暗装(需接地线)

颜色 Colour : ● 雅黑 ● 雅白 ● 拉丝枪灰 ● 拉丝黄铜

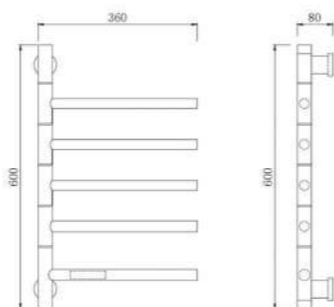

F-CR04P

管型 Tube Type: 圆管

尺寸 Size: 580*410*130 mm

开关 Switch: 旋钮温控WIFI开关

电压 Voltage: 220v

功率 Rating: 60w

材质 Material: 304不锈钢

安装方式 Install: 明装/暗装(需接地线)

颜色 colour: ● 雅黑 ● 雅白 ● 拉丝枪灰 ● 拉丝黄铜

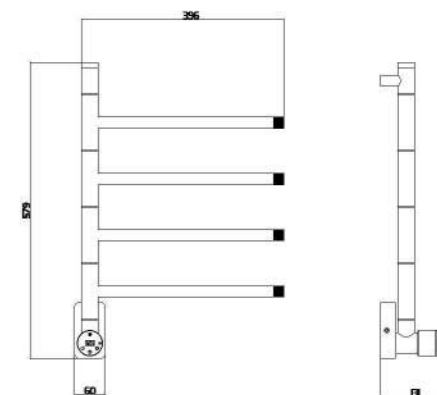

F-LS04

管型 Tube Type : 扁管

尺寸 Size: 600*360*80 mm

开关 Switch: 触屏恒温时控1-8H

电压 Voltage: 12V/220-240V

功率 Rating: 55W

材质 Material: 304不锈钢

安装方式 Install: 暗装(需接地线)

颜色 Colour : ● 雅黑 ● 雅白 ● 拉丝枪灰 ● 拉丝黄铜

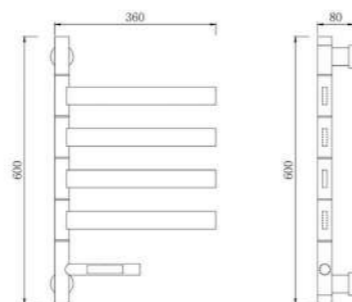

F-CR04G

管型 Tube Type: 圆管

尺寸 Size: 670*410*80 mm

开关 Switch: 触屏恒温时控1-8H

电压 Voltage: 220v

功率 Rating: 65w

材质 Material: 304不锈钢

安装方式 Install: 明装/暗装(需接地线)

颜色 colour: ● 雅黑 ● 雅白 ● 拉丝枪灰 ● 拉丝黄铜

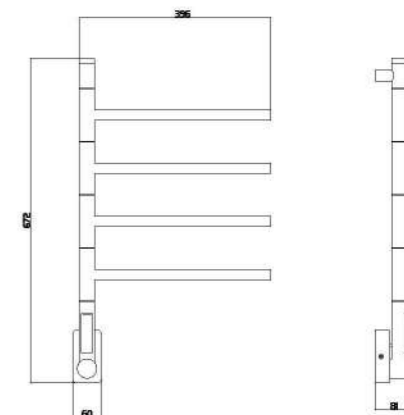

智能电热毛巾架-星月系列



Q-SR06

描述 Describe : SUS304

尺寸 Size: 800*500*80mm

功率 Rating: 85W

开关 Switch: 触屏控时控温开关
(定时: 1-8H)
(控温: 40°-60°)

电压 Voltage: 220V

颜色 Colour :

● 雅黑 ● 雅白 ● 拉丝枪灰 ● 拉丝黄铜

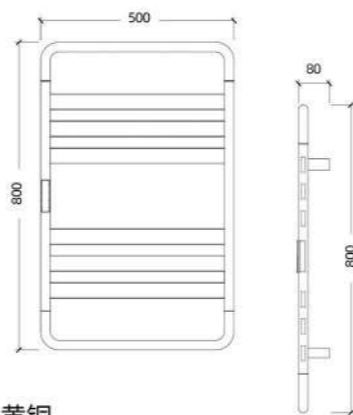

Q-LS05

描述 Describe : SUS304

尺寸 Size: 800*500*136mm

功率 Rating: 50W

开关 Switch: 触屏控时控温开关
(定时: 1-8H)
(控温: 40°-60°)

电压 Voltage: 220V

颜色 Colour :

● 雅黑 ● 雅白 ● 拉丝枪灰 ● 拉丝黄铜

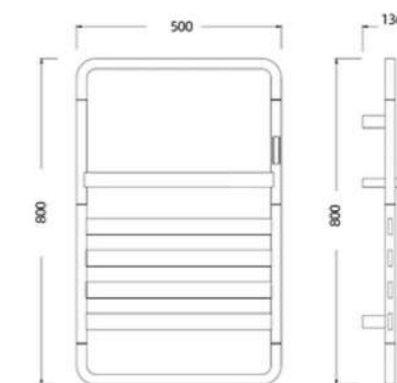

Q-LS05P

描述 Describe : SUS304

尺寸 Size: 900*450*130mm

功率 Rating: 65W

开关 Switch: 旋钮温时控WIFI开关
(定时: 1-8H)
(控温: 40°-60°)

电压 Voltage: 220V

颜色 Colour :

● 雅黑 ● 雅白 ● 拉丝枪灰 ● 拉丝黄铜

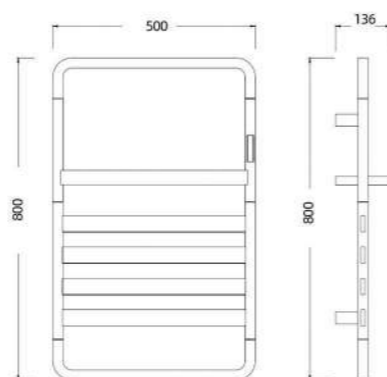

Q-LS04

描述 Describe : SUS304

尺寸 Size: 800*500*136mm

功率 Rating: 50W

开关 Switch: 触屏控时控温开关
(定时: 1-8H)
(控温: 40°-60°)

电压 Voltage: 220V

颜色 Colour :

● 雅黑 ● 雅白 ● 拉丝枪灰 ● 拉丝黄铜

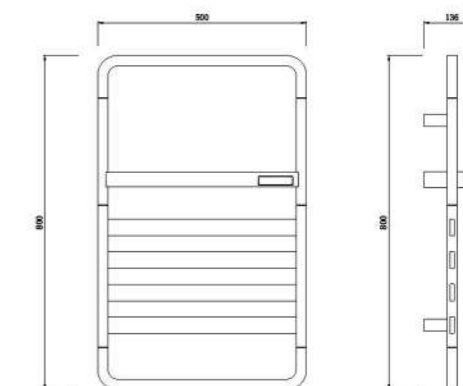

智能电热毛巾架-90度系列



B-CR05

管型 Tube Type : 竖管32mm
横管22mm

尺寸 Size: 600*850*100 mm

功率 Rating: 80W

开关 Switch: 1-8H温控开关

电压 Voltage: 12V/220-240V

颜色 Colour :

● 镜光 ● 砂光 ● 黄铜 ● 哑黑 ● 哑白 ● ORB ● 枪灰 ● 钛金 ● 玫瑰金

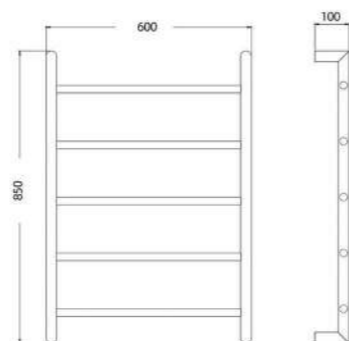

智能电热毛巾架-梦缘系列



J-CR09

管型 Tube Type : 竖管32mm
横管22mm

尺寸 Size: 600*230*600 mm

功率 Rating: 140W

开关 Switch: 普遍圆型开关/
(三选一) 金属LED开关/
1-8H温控开关

电压 Voltage: 12V/220-240V

颜色 Colour :

● 镜光 ● 砂光 ● 黄铜 ● 哑黑 ● 哑白 ● ORB ● 枪灰 ● 钛金 ● 玫瑰金

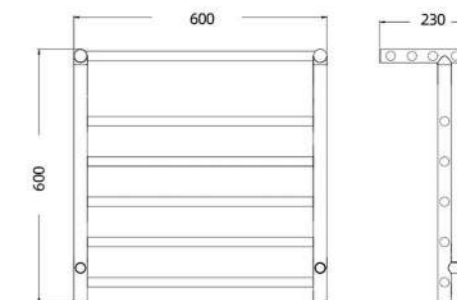

B-CS05

管型 Tube Type : 竖管30mm
横管19mm

尺寸 Size: 630*850*100 mm

功率 Rating: 100W

开关 Switch: 1-8H温控开关

电压 Voltage: 12V/220-240V

颜色 Colour :

● 镜光 ● 砂光 ● 黄铜 ● 哑黑 ● 哑白 ● ORB ● 枪灰 ● 钛金 ● 玫瑰金

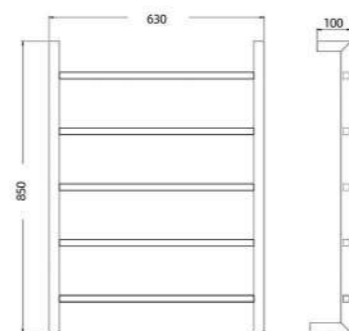

J-CS09

管型 Tube Type : 竖管32mm
横管22mm

尺寸 Size: 600*230*600 mm

功率 Rating: 140W

开关 Switch: 普遍圆型开关/
(三选一) 金属LED开关/
1-8H温控开关

电压 Voltage: 12V/220-240V

颜色 Colour :

● 镜光 ● 砂光 ● 黄铜 ● 哑黑 ● 哑白 ● ORB ● 枪灰 ● 钛金 ● 玫瑰金

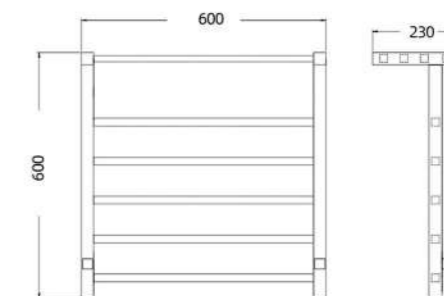

智能电热毛巾架-秋漫系列

A-CR03



管型 Tube Type : 竖管 32mm
横管 22mm
尺寸 Size: 500*121.8*280 mm
功率 Rating: 35W
开关 Switch: 普遍圆型开关/
(三选一) 金属LED开关/
1-8H温控开关
电压 Voltage: 12V/220-240V
颜色 Colour :

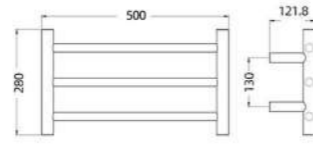

●镜光 ●砂光 ●枪灰 ●黄铜 ●哑黑 ●哑白 ●钛金 ●ORB

A-CR07



管型 Tube Type : 竖管 32mm
横管 22mm
尺寸 Size: 600*121.8*790 mm
功率 Rating: 110W
开关 Switch: 普遍圆型开关/
(三选一) 金属LED开关/
1-8H温控开关
电压 Voltage: 12V/220-240V
颜色 Colour :

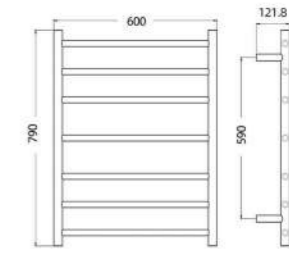

●镜光 ●砂光 ●枪灰 ●黄铜 ●哑黑 ●哑白 ●钛金 ●ORB

A-CR05



管型 Tube Type : 竖管 32mm
横管 22mm
尺寸 Size: 600*121.8*550 mm
功率 Rating: 70W
开关 Switch: 普遍圆型开关/
(三选一) 金属LED开关/
1-8H温控开关
电压 Voltage: 12V/220-240V
颜色 Colour :

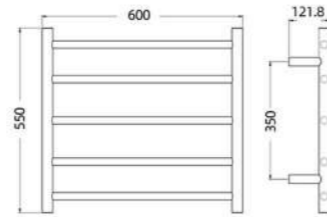

●镜光 ●砂光 ●枪灰 ●黄铜 ●哑黑 ●哑白 ●钛金 ●ORB

A-CR09



管型 Tube Type : 竖管 32mm
横管 22mm
尺寸 Size: 600*121.8*1060 mm
功率 Rating: 125W
开关 Switch: 普遍圆型开关/
(三选一) 金属LED开关/
1-8H温控开关
电压 Voltage: 12V/220-240V
颜色 Colour :

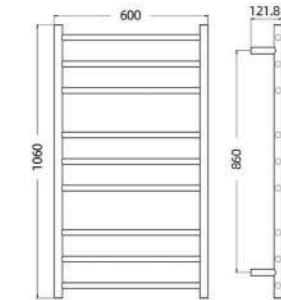

●镜光 ●砂光 ●枪灰 ●黄铜 ●哑黑 ●哑白 ●钛金 ●ORB

A-CR06



管型 Tube Type : 竖管 32mm
横管 22mm
尺寸 Size: 600*121.8*620 mm
功率 Rating: 95W
开关 Switch: 普遍圆型开关/
(三选一) 金属LED开关/
1-8H温控开关
电压 Voltage: 12V/220-240V
颜色 Colour :

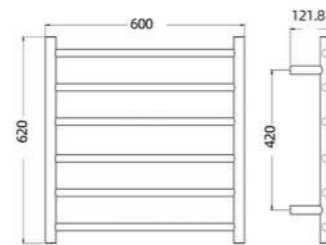

●镜光 ●砂光 ●枪灰 ●黄铜 ●哑黑 ●哑白 ●钛金 ●ORB

A-CR11



管型 Tube Type : 竖管 32mm
横管 22mm
尺寸 Size: 600*121.8*1220 mm
功率 Rating: 140W
开关 Switch: 普遍圆型开关/
(三选一) 金属LED开关/
1-8H温控开关
电压 Voltage: 12V/220-240V
颜色 Colour :

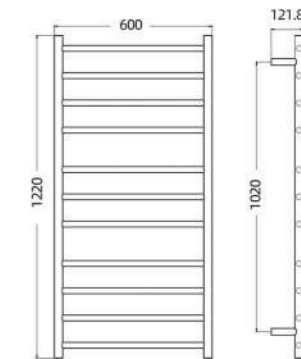

●镜光 ●砂光 ●枪灰 ●黄铜 ●哑黑 ●哑白 ●钛金 ●ORB

智能电热毛巾架-秋漫系列

A-CS03

管型 Tube Type : 竖管 30mm
横管 19mm

尺寸 Size: 500*120*550 mm

功率 Rating: 38W

开关 Switch: 普遍圆型开关/
(三选一) 金属LED开关/
1-8H温控开关

电压 Voltage: 12V / 220-240V

颜色 Colour :

● 镜光 ● 砂光 ● 黄铜 ● 哑黑 ● 哑白 ● ORB ● 枪灰 ● 钛金 ● 玫瑰金

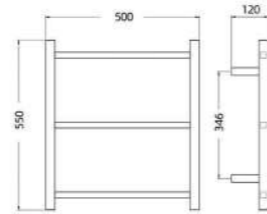

A-CS08

管型 Tube Type : 竖管 30mm
横管 19mm

尺寸 Size: 600*120*912 mm

功率 Rating: 115W

开关 Switch: 普遍圆型开关/
(三选一) 金属LED开关/
H温控开关

电压 Voltage: 12V / 220-240V

颜色 Colour :

● 镜光 ● 砂光 ● 黄铜 ● 哑黑 ● 哑白 ● ORB ● 枪灰 ● 钛金 ● 玫瑰金

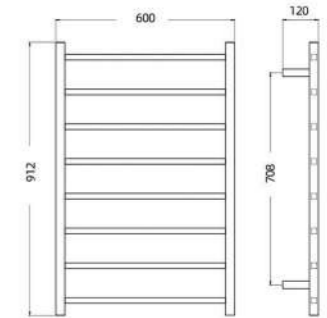

A-CS05

管型 Tube Type : 竖管 30mm
横管 19mm

尺寸 Size: 600*120*510 mm

功率 Rating: 70W

开关 Switch: 普遍圆型开关/
(三选一) 金属LED开关/
1-8H温控开关

电压 Voltage: 12V / 220-240V

颜色 Colour :

● 镜光 ● 砂光 ● 黄铜 ● 哑黑 ● 哑白 ● ORB ● 枪灰 ● 钛金 ● 玫瑰金

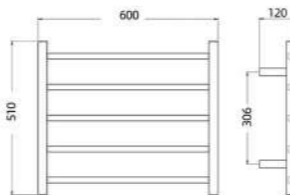

A-CS09

管型 Tube Type : 竖管 30mm
横管 19mm

尺寸 Size: 600*120*1050 mm

功率 Rating: 125W

开关 Switch: 普遍圆型开关/
(三选一) 金属LED开关/
1-8H温控开关

电压 Voltage: 12V / 220-240V

颜色 Colour :

● 镜光 ● 砂光 ● 黄铜 ● 哑黑 ● 哑白 ● ORB ● 枪灰 ● 钛金 ● 玫瑰金

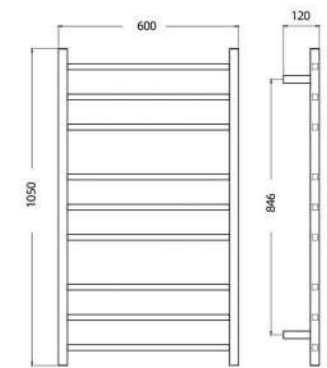

A-CS06

管型 Tube Type : 竖管 30mm
横管 19mm

尺寸 Size: 600*120*675 mm

功率 Rating: 85W

开关 Switch: 普遍圆型开关/
(三选一) 金属LED开关/
1-8H温控开关

电压 Voltage: 12V / 220-240V

颜色 Colour :

● 镜光 ● 砂光 ● 黄铜 ● 哑黑 ● 哑白 ● ORB ● 枪灰 ● 钛金 ● 玫瑰金

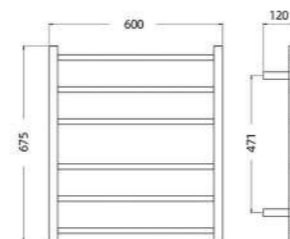

A-CS11

管型 Tube Type : 竖管 30mm
横管 19mm

尺寸 Size: 600*120*1220 mm

功率 Rating: 155W

开关 Switch: 普遍圆型开关/
(三选一) 金属LED开关/
1-8H温控开关

电压 Voltage: 12V / 220-240V

颜色 Colour :

● 镜光 ● 砂光 ● 黄铜 ● 哑黑 ● 哑白 ● ORB ● 枪灰 ● 钛金 ● 玫瑰金

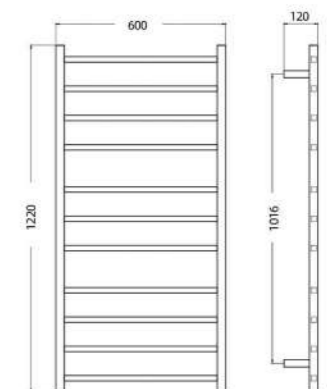

智能电热毛巾架-秋漫系列

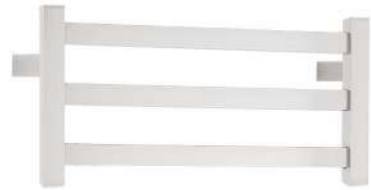

A-LS03

管型 Tube Type : 竖管 38*25mm
横管 40*20mm

尺寸 Size: 500*115*280 mm

功率 Rating: 45W

开关 Switch: 普遍圆型开关/
(三选一) 金属LED开关/
1-8H温控开关

电压 Voltage: 220-240V

颜色 Colour :

● 镜光 ● 砂光 ● 黄铜 ● 哑黑 ● 哑白 ● ORB ● 枪灰 ● 钛金 ● 玫瑰金

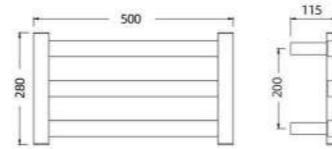

A-LS09

管型 Tube Type : 竖管 38*25mm
横管 40*20mm

尺寸 Size: 500*115*1000 mm

功率 Rating: 125W

开关 Switch: 普遍圆型开关/
(三选一) 金属LED开关/
1-8H温控开关

电压 Voltage: 220-240V

颜色 Colour :

● 镜光 ● 砂光 ● 黄铜 ● 哑黑 ● 哑白 ● ORB ● 枪灰 ● 钛金 ● 玫瑰金

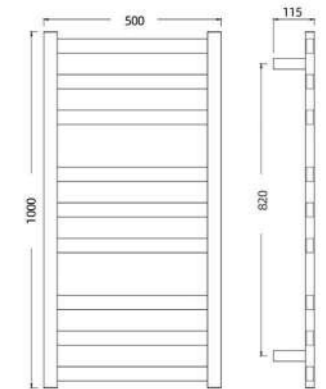

A-LS06

管型 Tube Type : 竖管 38*25mm
横管 40*20mm

尺寸 Size: 500*115*640 mm

功率 Rating: 80W

开关 Switch: 普遍圆型开关/
(三选一) 金属LED开关/
1-8H温控开关

电压 Voltage: 220-240V

颜色 Colour :

● 镜光 ● 砂光 ● 黄铜 ● 哑黑 ● 哑白 ● ORB ● 枪灰 ● 钛金 ● 玫瑰金

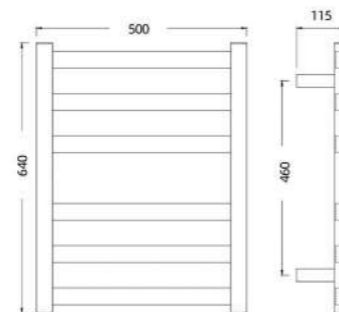

A-LS10

管型 Tube Type : 竖管 38*25mm
横管 40*20mm

尺寸 Size: 600*115*870 mm

功率 Rating: 155W

开关 Switch: 普遍圆型开关/
(三选一) 金属LED开关/
1-8H温控开关

电压 Voltage: 220-240V

颜色 Colour :

● 镜光 ● 砂光 ● 黄铜 ● 哑黑 ● 哑白 ● ORB ● 枪灰 ● 钛金 ● 玫瑰金

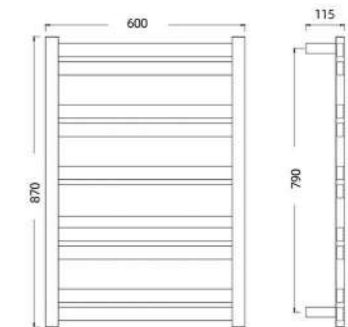

智能电热毛巾架-BALL SERIES系列



H-SB05

管型 Tube Type : 竖管25mm
横管19mm

尺寸 Size: 570*850*136.5mm

功率 Rating: 60W

开关 Switch: 1-8H温控开关

电压 Voltage: 12V/220-240V

颜色 Colour :

● 镜光 ● 砂光 ● 黄铜 ● 哑黑 ● 哑白 ● ORB ● 枪灰 ● 钛金 ● 玫瑰金

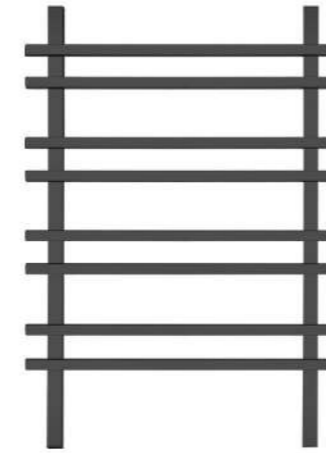
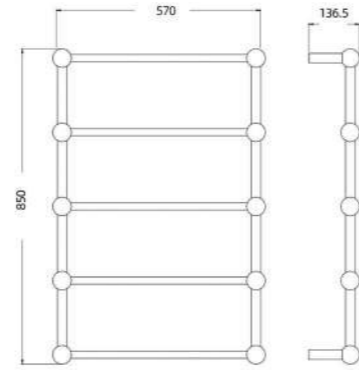

PLUS SERIES系列

A-CS08-9

管型 Tube Type : 竖管30mm
横管19mm

尺寸 Size: 600*800*139mm

功率 Rating: 94W

电压 Voltage: 12V/220-240V

颜色 Colour :

● 镜光 ● 砂光 ● 黄铜 ● 哑黑 ● 哑白 ● ORB ● 枪灰 ● 钛金 ● 玫瑰金

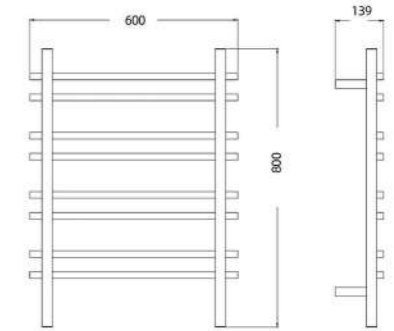

H-SB07

管型 Tube Type : 竖管25mm
横管19mm

尺寸 Size: 700*1190*136.5mm

功率 Rating: 100W

开关 Switch: 1-8H温控开关

电压 Voltage: 12V/220-240V

颜色 Colour :

● 镜光 ● 砂光 ● 黄铜 ● 哑黑 ● 哑白 ● ORB ● 枪灰 ● 钛金 ● 玫瑰金

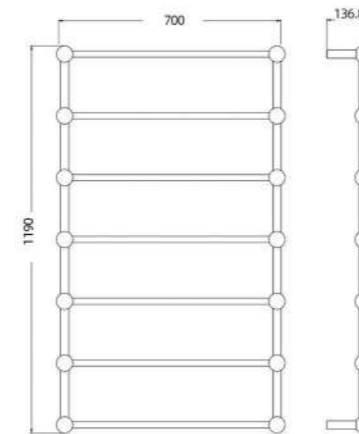

夏露系列

T-SR08

描述 Describe : SUS304

尺寸 Size: 800*500*200mm

功率 Rating: 115W

开关 Switch: 触屏控时控温开关
(定时: 1-8H)
(控温: 40°-60°)

电压 Voltage: 220V

颜色 Colour :

● 雅黑 ● 雅白 ● 拉丝枪灰 ● 拉丝黄铜

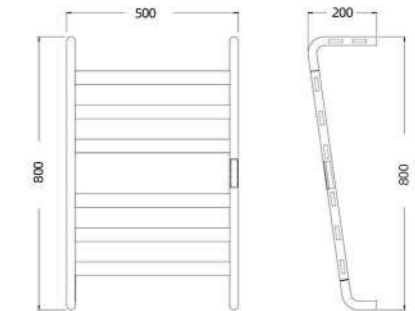

智能电热毛巾架-S系列



E-WC01

管型 Tube Type : 圆管25mm

尺寸 Size: 615*575*100 mm

功率 Rating: 45W

开关 Switch: 普遍圆型开关/
(三选一)

金属LED开关/

1-8H温控开关

电压 Voltage: 12V/220-240V

颜色 Colour :

● 镜光 ● 砂光 ● 黄铜 ● 哑黑 ● 哑白 ● ORB ● 枪灰 ● 钛金 ● 玫瑰金

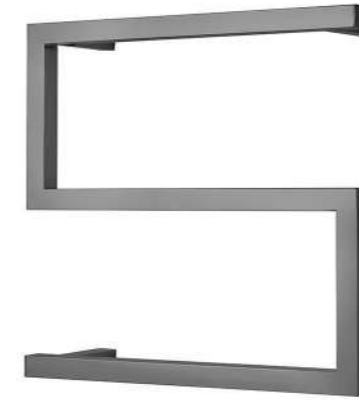
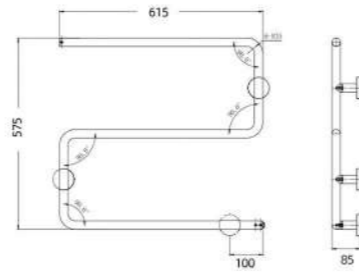

E-WB03-1

管型 Tube Type : 方管40*20mm

尺寸 Size: 500*525*120mm

功率 Rating: 55W

开关 Switch: 普遍圆型开关/
(三选一)

金属LED开关/

1-8H温控开关

电压 Voltage: 12V/220-240V

颜色 Colour :

● 镜光 ● 砂光 ● 黄铜 ● 哑黑 ● 哑白 ● ORB ● 枪灰 ● 钛金 ● 玫瑰金

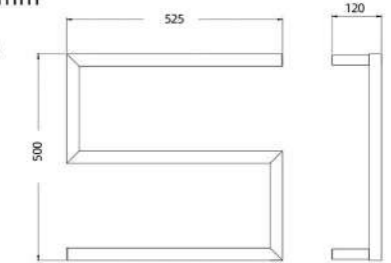

E-WA01

管型 Tube Type : 圆管25mm

尺寸 Size: 605*730*85 mm

功率 Rating: 65W

开关 Switch: 普遍圆型开关/
(三选一)

金属LED开关/

1-8H温控开关

电压 Voltage: 12V/220-240V

颜色 Colour :

● 镜光 ● 砂光 ● 黄铜 ● 哑黑 ● 哑白 ● ORB ● 枪灰 ● 钛金 ● 玫瑰金

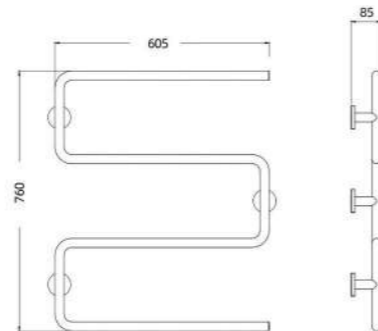

E-WB03

管型 Tube Type : 方管30mm

尺寸 Size: 525*500*120 mm

功率 Rating: 57W

开关 Switch: 普遍圆型开关/
(三选一)

金属LED开关/

1-8H温控开关

电压 Voltage: 12V/220-240V

颜色 Colour :

● 镜光 ● 砂光 ● 黄铜 ● 哑黑 ● 哑白 ● ORB ● 枪灰 ● 钛金 ● 玫瑰金

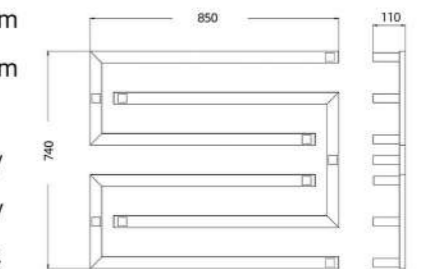

智能电热毛巾架-单杆款



D-CR01

管型 Tube Type : 圆管

功率 Rating: 15W

尺寸 Size: 650*100*32 mm

电压 Voltage: 12V/220-240V

材质 Material: 304不锈钢

颜色 Colour :

● 镜光 ● 砂光 ● 哑黑 ● 哑白 ● 枪灰 ● 黄铜 ● 钛金 ● ORB ● 玫瑰金



D-LS01

管型 Tube Type : 扁管

功率 Rating: 15W

尺寸 Size: 650*100*40mm

电压 Voltage: 12V/220-240V

材质 Material: 304不锈钢

颜色 Colour :

● 镜光 ● 砂光 ● 哑黑 ● 哑白 ● 枪灰 ● 黄铜 ● 钛金 ● ORB ● 玫瑰金

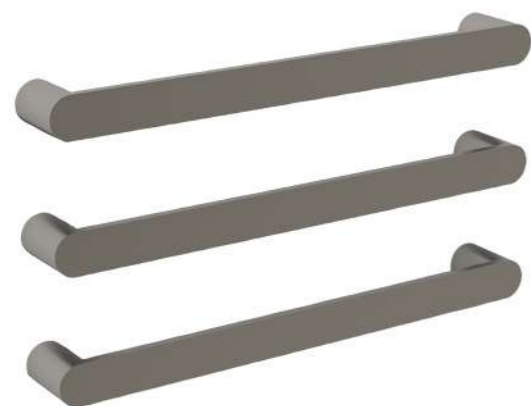

D-LS02

管型 Tube Type : 扁管

功率 Rating: 12-15W

尺寸 Size: 650*72*50 mm

电压 Voltage: 12V/220-240V

材质 Material: 304不锈钢

颜色 Colour :

● 镜光 ● 砂光 ● 哑黑 ● 哑白 ● 枪灰 ● 黄铜 ● 钛金 ● ORB ● 玫瑰金



D-LS03

管型 Tube Type : 扁管

功率 Rating: 12-15W

尺寸 Size: 850*72*50 mm

电压 Voltage: 12V/220-240V

材质 Material: 304不锈钢

颜色 Colour :

● 镜光 ● 砂光 ● 哑黑 ● 哑白 ● 枪灰 ● 黄铜 ● 钛金 ● ORB ● 玫瑰金

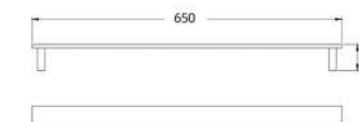

智能电热毛巾架-多杆款

D-CR01C



管型 Tube Type : 圆管

功率 Rating: 15W

尺寸 Size: 700*100*32 mm

电压 Voltage: 12V/220-240V

材质 Material: 304不锈钢

颜色 Colour :

● 镜光 ● 砂光 ● 哑黑 ● 哑白 ● 枪灰 ● 黄铜 ● 钛金 ● ORB ● 玫瑰金

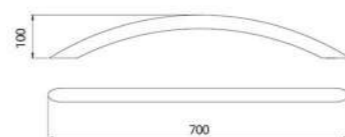

D-LS01C



管型 Tube Type : 扁管

功率 Rating: 15W

尺寸 Size: 700*100*32mm

电压 Voltage: 12V/220-240V

材质 Material: 304不锈钢

颜色 Colour :

● 镜光 ● 砂光 ● 哑黑 ● 哑白 ● 枪灰 ● 黄铜 ● 钛金 ● ORB ● 玫瑰金

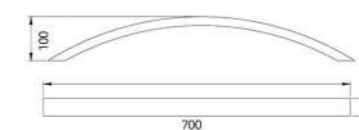

D-LS02



管型 Tube Type : 圆管

功率 Rating: 15W

尺寸 Size: 650*100 mm

电压 Voltage: 12V/220-240V

材质 Material: 304不锈钢

颜色 Colour :

● 镜光 ● 砂光 ● 哑黑 ● 哑白 ● 枪灰 ● 黄铜 ● 钛金 ● ORB ● 玫瑰金



D-CR03



管型 Tube Type : 圆管

功率 Rating: 12-15W

尺寸 Size: 650*100*50 mm

电压 Voltage: 12V/220-240V

材质 Material: 304不锈钢

颜色 Colour :

● 镜光 ● 砂光 ● 哑黑 ● 哑白 ● 枪灰 ● 黄铜 ● 钛金 ● ORB ● 玫瑰金

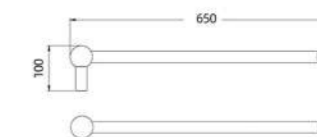

智能电热毛巾架-竖立款



K-CR01

管型 Tube Type : 圆管
 功率 Rating: 33W
 尺寸 Size: 1720*80 mm
 电压 Voltage: 12V/220-240V
 开关 Switch: 普遍圆型开关/
 (三选一) 金属LED开关/
 1-8H温控开关

材质 Material: 304不锈钢

颜色 Colour :

● 镜光 ● 砂光 ● 哑黑 ● 哑白 ● 枪灰 ● 黄铜 ● 钛金 ● ORB ● 玫瑰金

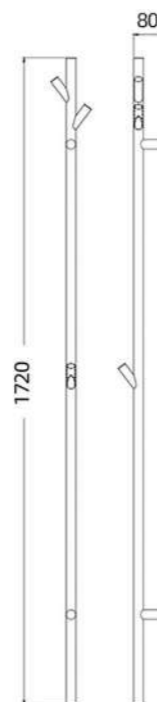

P-CS3

管型 Tube Type : 方竖管
 功率 Rating: 56W
 尺寸 Size: 1200*180*170 mm
 电压 Voltage: 12V/220-240V
 开关 Switch: 普遍圆型开关/
 (三选一) 金属LED开关/
 1-8H温控开关

材质 Material: 304不锈钢

● 镜光 ● 砂光 ● 哑黑 ● 哑白 ● 枪灰 ● 黄铜 ● 钛金 ● ORB ● 玫瑰金

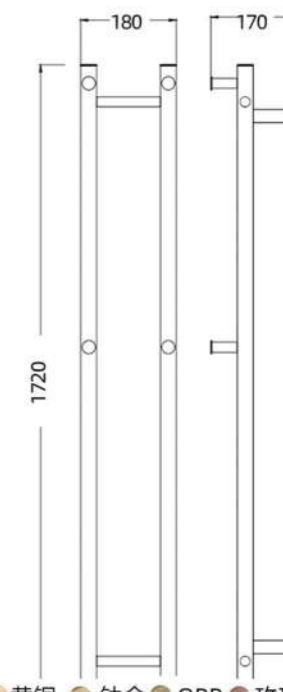

I-CR01

管型 Tube Type : 圆管
 功率 Rating: 25-30W
 尺寸 Size: 900*100 mm
 电压 Voltage: 12V/220-240V
 开关 Switch: 普遍圆型开关/
 (三选一) 金属LED开关/
 1-8H温控开关

材质 Material: 304不锈钢

颜色 Colour :

● 镜光 ● 砂光 ● 哑黑 ● 哑白 ● 枪灰 ● 黄铜 ● 钛金 ● ORB ● 玫瑰金



I-CR01H

管型 Tube Type : 圆管
 功率 Rating: 25-30WW
 尺寸 Size: 900*100*142 mm
 电压 Voltage: 12V/220-240V
 开关 Switch: 普遍圆型开关/
 (三选一) 金属LED开关/
 1-8H温控开关

材质 Material: 304不锈钢

颜色 Colour :

● 镜光 ● 砂光 ● 哑黑 ● 哑白 ● 枪灰 ● 黄铜 ● 钛金 ● ORB ● 玫瑰金



智能电热毛巾架-落地款



C-SR06

管型 Tube Type : 竖管30mm
横管22mm

功率 Rating: 80W

尺寸 Size: 600*300*800 mm

电压 Voltage: 220-240V

开关 Switch: 普遍圆型开关 / 金属LED开关 / 1-8H温控开关
(三选一)

颜色 Colour :

● 镜光 ● 砂光 ● 哑黑 ● 哑白 ● 枪灰 ● 黄铜 ● 钛金 ● ORB ● 玫瑰金

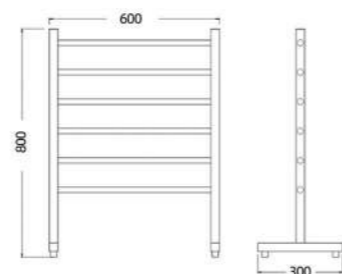

G-CR01

管型 Tube Type : 竖管50mm
横管22mm

尺寸 Size: 1000*1000*1000mm

功率 Rating: 61W

电压 Voltage: 12V/220-240V

颜色 Colour :

● 镜光 ● 砂光 ● 哑黑 ● 哑白 ● 枪灰 ● 黄铜 ● 钛金 ● ORB ● 玫瑰金



C-CR08

管型 Tube Type : 竖管32mm
横管22mm

功率 Rating: 86W

尺寸 Size: 600*300*1080mm

电压 Voltage: 220-240V

开关 Switch: 普遍圆型开关 / 金属LED开关 / 1-8H温控开关
(三选一)

颜色 Colour :

● 镜光 ● 砂光 ● 哑黑 ● 哑白 ● 枪灰 ● 黄铜 ● 钛金 ● ORB ● 玫瑰金

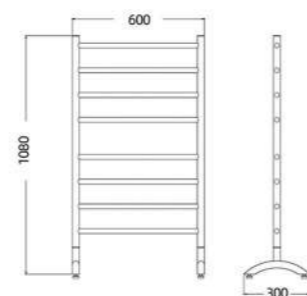

G-CR03

管型 Tube Type : 竖管50mm

尺寸 Size: 1000、800、700mm

功率 Rating: 53W

电压 Voltage: 12V/220-240V

颜色 Colour :

● 镜光 ● 砂光 ● 哑黑 ● 哑白 ● 枪灰 ● 黄铜 ● 钛金 ● ORB ● 玫瑰金

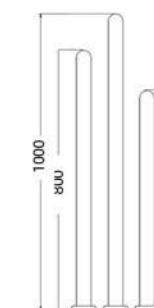

STARS SERIES

顶天立地系列 (非标定制)



Q-LS13PM

管型 Tube Type: 竖管25.4mm

功率 Rating: 160w

尺寸 Size: 2400-2800*554*138mm

(可定制高度)

电压 Voltage: 12V/220-240V

颜色 Colour: ● 镜光 ● 砂光

● 哑黑 ● 哑白

● 枪灰 ● 黄铜

● 钛金 ● ORB

● 玫瑰金

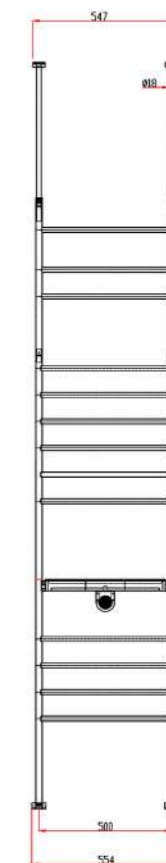

G-CR02

管型 Tube Type: 竖管50mm

功率 Rating: 280W

尺寸 Size: 700*3000mm

电压 Voltage: 12V/220-240V

颜色 Colour: ● 镜光 ● 砂光

● 哑黑 ● 哑白

● 枪灰 ● 黄铜

● 钛金 ● ORB

● 玫瑰金

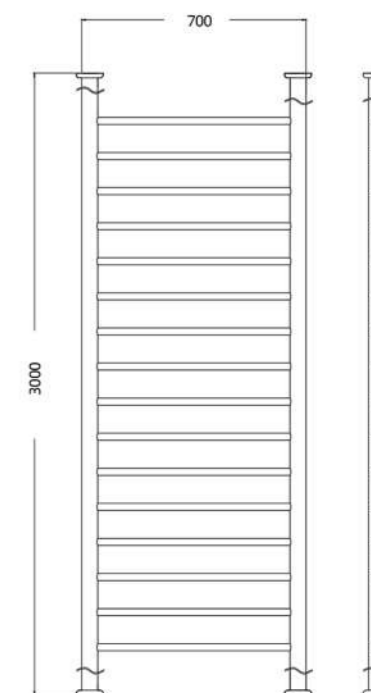

智能电热烘干机



型号: MJ01

电压	防水等级
AC 220V	IPX2
功率	尺寸
550W	600x128x100mm

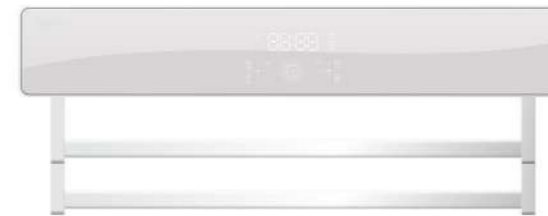
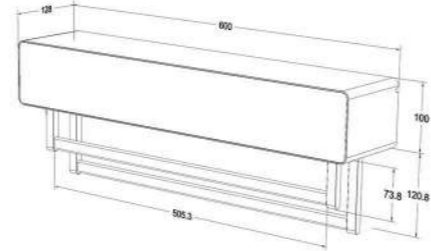

型号: MJ02

电压	防水等级
AC 220V	IPX2
功率	尺寸
550W	600x128x100mm

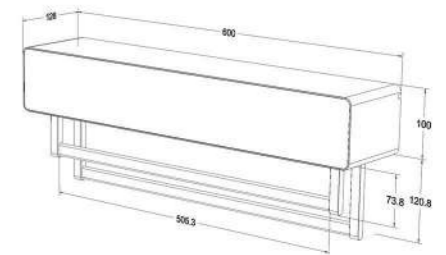

型号: MJ03

电压	防水等级
AC 220V	IPX2
功率	尺寸
550W	600x128x100mm

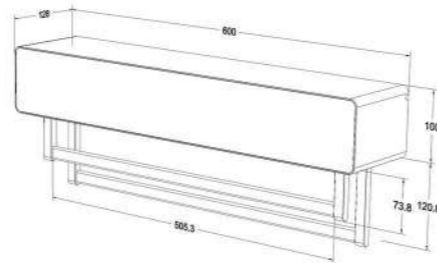

型号: MJ04

电压	防水等级
AC 220V	IPX2
功率	尺寸
550W	600x128x100mm

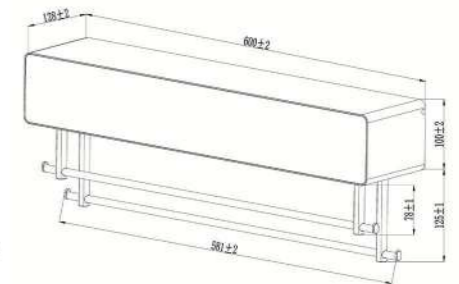

型号: MJ06

电压	防水等级
AC 220V	IPX2
功率	尺寸
550W	500x128x100mm

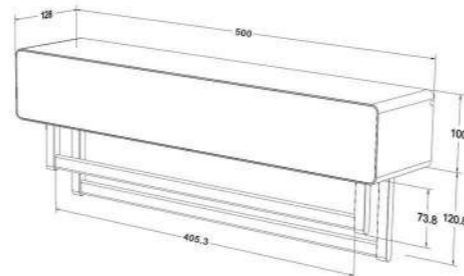

型号: MJ10

电压	防水等级
AC 220V	IPX2
功率	尺寸
550W	600x162x75mm





Precision casting mounting cover and plate
timeless design

Material 材料 SS304

Finish 表面 Mirror, Matt black, Brushed brass, Rose gold, Gun metal



JA01
Single towel bar
单杆



JA02
Double towel bar
双杆



JA03
Glass shelf
置物架



JA04
Towel rack
沐浴架



JA05
Roll paper holder
纸巾架



JA06
Paper holder
纸巾架



JA07
Towel ring
毛巾环



JA08
Soap holder
皂碟架



JA09
Glass cup holder
杯架



JA10
Single robe hook
衣钩



JA11
Double robe hook
双衣钩



JA12
Toilet brush holder
马桶刷



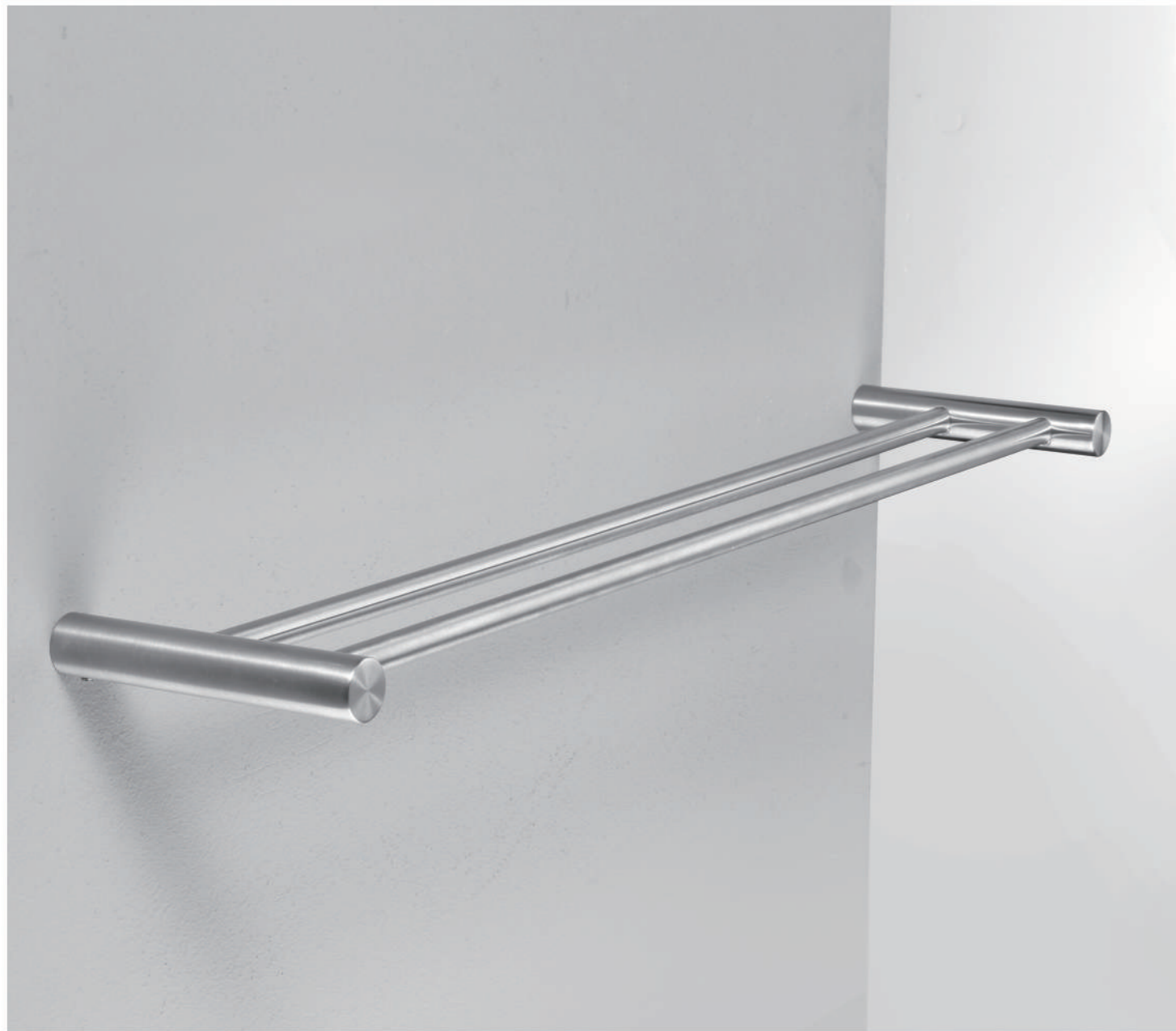

Precision casting mounting cover and plate
timeless design

Material 材料 SS304

Finish 表面 Mirror, Matt black, Brushed brass, Rose gold, Gun metal



JB01

Single towel bar
单杆



JB02

Double towel bar
双杆



JB03

Toilet tissue holder
单卷纸巾架



JB04

Toilet tissue holder
双卷纸巾架



JB05

Roll paper holder
纸巾架



JB06

Paper holder
纸巾架



JB07

Towel ring
毛巾环



JB08

Soap holder
皂碟架



JB09

Shelf with soap holder
置物架



JB10

Shelf
置物架



JB11

Single robe hook
单衣钩



JB12

Double robe hook
双衣钩





Precision casting mounting cover and plate
timeless design

Material 材料 SS304

Finish 表面 Mirror, Matt black, Brushed brass, Rose gold, Gun metal



JD01
Single towel bar
单杆



JD02
Double towel bar
双杆



JD03
Shelf
置物架



JD04
Towel rack
沐浴架



JD05
Paper holder with cover
纸巾架



JD07
Towel ring
纸巾架



JD08
Soap holder
毛巾环



JD09
Glass cup holder
皂碟架



JD10
Single robe hook
杯架



JD11
Double robe hook
衣钩



JD12
Toilet brush holder
双衣钩



JD16
Toilet brush holder
马桶刷





**Precision casting mounting cover and plate
timeless design**

Material 材料 SS304

Finish 表面 Mirror, Matt black, Brushed brass, Rose gold, Gun metal



JE01

Single towel bar
单杆

JE02

Double towel bar
双杆

JE03

Shelf
置物架

JE04

Towel rack
沐浴架

JE05

Paper holder
纸巾架

JE07

Towel holder
毛巾架

JE08

Soap holder
皂碟架

JE09

Glass cup holder
杯架

JE10

Robe hook
袍钩

JE11

Toilet brush holder
衣钩



Precision casting mounting cover and plate
timeless design

Material 材料 SS304

Finish 表面 Mirror, Matt black, Brushed brass, Rose gold, Gun metal



J101
Single towel bar
单杆



J102
Double towel bar
双杆



J104
Towel rack
浴巾架



J106
Roll paper holder
备用纸巾架



J108
Soap holder
皂碟架



J109
Glass cup holder
杯架



J110
Robe hook
毛巾环



J112
Toilet brush holder
皂碟架





Precision casting mounting cover and plate
timeless design

Material 材料 SS304

Finish 表面 Mirror, Matt black, Brushed brass, Rose gold, Gun metal



JJ01

Single towel bar
单杆



JJ02

Double towel bar
双杆



JJ04

Towel rack
浴巾架



JJ05

Paper holder with cover
纸巾架



JJ06

Roll paper holder
备用纸巾架



JJ07

Towel ring
毛巾环



JJ08

Soap holder
皂碟架



JJ09

Glass cup holder
杯架



JJ10

Robe hook
衣钩



JJ12

Toilet brush holder
马桶刷





Precision casting mounting cover and plate
timeless design

Material 材料 SS304

Finish 表面 Mirror, Matt black, Brushed brass, Rose gold, Gun metal



JK01
Single towel bar
单杆



JK02
Double towel bar
双杆



JK03
Glass shelf
置物架



JK04
Towel rack
沐浴架



JK05
Roll paper holder
纸巾架



JK07
Towel ring
毛巾环



JK08
Soap holder
皂碟架



JK09
Glass cup holder
杯架



JK11
Double robe hook
衣钩



JK12
Toilet brush holder
马桶刷



Precision casting mounting cover and plate
timeless design

Material 材料 SS304

Finish 表面 Mirror, Matt black, Brushed brass, Rose gold, Gun metal



JL01
Towel bar
单杆



JL02
Double towel bar
双杆



JL03
Shelf
置物架



JL04
Towel rack
沐浴架



JL05
Roll paper holder
纸巾架



JL08
Soap holder
皂碟架



JL09
Double glass cup holder
双单杯



JL10
Robe hook
衣钩



JL12
Toilet brush holder
马桶刷





JM01
Single towel bar
单杆毛巾架



JM02
Double towel bar
双杆毛巾架



JM03
Towel rack
毛巾架



JM04
Towel ring
毛巾环



JM05
Robe hook
衣钩



JM06
Glass cup holder
牙刷架



JM07
Double glass cup holder
双牙刷架



JM08
Soap holder
皂碟架



JM09
Basket
网篮



JM10
Roll paper holder
纸巾架 (带盖)



JM11
Paper holder
纸巾架



JM12
Toilet brush holder
马桶刷



精选底座:





JT01
Single towel bar
单杆



JT02
Double towel bar
双杆



JT03
Towel rack
毛巾架



JT04
Towel ring
毛巾环



JT05
Paper holder
纸巾架



JT06
Paper holder
纸巾架 (带盖)



JT07
Toilet Paper Holder
单边卷纸架



JT08
Double Toilet
Paper Holder
T型卷纸架



JT09
Toilet Paper Holder
卷纸架



JT10
Double Toilet
Paper Holder
双卷纸架



JT11
Robe Hook
挂钩



JT12
Robe Hook
衣钩



JT13
Soap holder
皂碟架



JT14
Glass cup holder
牙刷架

精选底座:





Precision casting mounting cover and plate
timeless design

Material 材料 SS304

Finish 表面 Mirror, Matt black, Brushed brass, Rose gold, Gun metal



JW01
Single towel bar
单杆毛巾架



JW02
Double towel bar
双杆毛巾架



JW03
Towel rack
毛巾架



JW04
Glass Shelf
玻璃置物架



JW05
Paper holder
厕纸架



JW06
Soap holder
皂碟架



JW07
Glass cup holder
牙刷架



JW08
Single robe hook
单衣钩



JW09
Double Robe Hook
双衣钩



JW10
Toilet Brush Holder
马桶刷





**Precision casting mounting cover and plate
timeless design**

Material 材料 SS304

Finish 表面 Mirror, Matt black, Brushed brass, Rose gold, Gun metal



JX01
Single towel bar
单杆毛巾架



JX02
Double towel bar
双杆毛巾架



JX03
Towel rack
毛巾架



JX04
Glass Shelf
玻璃置物架



JX05
Paper holder
厕纸架



JX06
Soap holder
皂碟架



JX07
Glass cup holder
牙刷杯



JX08
Towel Ring
毛巾环



JX09
Toilet Brush Holder
马桶刷





JY01
Single towel bar
单杆毛巾架



JY02
Double towel bar
双杆毛巾架



JY03
Towel rack
毛巾架



JY04
Glass Shelf
玻璃置物架



JY05
Paper holder
双纸巾架



JY06
Paper holder
单纸巾架



JY07
Towel Ring
毛巾环



JY08
Soap Holder
皂碟架



JY09
Glass cup holder
牙刷架



JY10
Single robe hook
单衣钩



JY11
Double Robe Hook
双衣钩



JY12
Toilet Brush Holder
马桶刷





JZ01
Single towel bar
单杆毛巾架



JZ02
Double towel bar
双杆毛巾架



JZ03
Towel rack
毛巾架



JZ04
Towel rack
毛巾架



JZ05
Paper holder
带盖纸巾架



JZ06
Paper holder
单纸巾架



JZ07
Paper holder
双纸架



JZ08
Soap Holder
皂碟架



JZ09
Glass cup holder
牙刷架



JZ10
Single robe hook
单衣钩



JZ11
Double Robe Hook
双衣钩



JZ12
Toilet Brush Holder
马桶刷



JZ13
Single robe hook
单衣钩





ZFG1
Single Towel Rack
毛巾架



ZFG1
Single Towel Bar
单杆毛巾架



ZFG4
Toilet Brushed Holder
马桶刷
马桶刷



ZFG5
Roll Paper Holder
厕纸架



ZFG6
Robe Hook
单衣钩



ZFG8
Paper towel holder
with storage
置物纸巾架



ZFG8S
Double Paper Holder
with cover
置物双纸巾架



ZFG9
Towel Ring
毛巾环



ZFG10
Glass Cup Holder
牙刷架



ZFF1
Single Towel Rack
毛巾架



ZFF3
Single Towel Bar
单杆毛巾架



ZFF6
Robe Hook
单衣钩



ZFF4
Toilet Brushed Holder
马桶刷



ZFF5
Roll Paper Holder
厕纸架

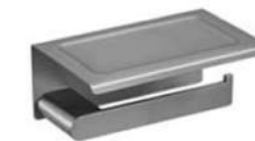

ZFF8
Paper towel holder
with storage
置物纸巾架



SHOWER ROD

不锈钢浴帘杆

经久耐用，防腐防锈不易变形

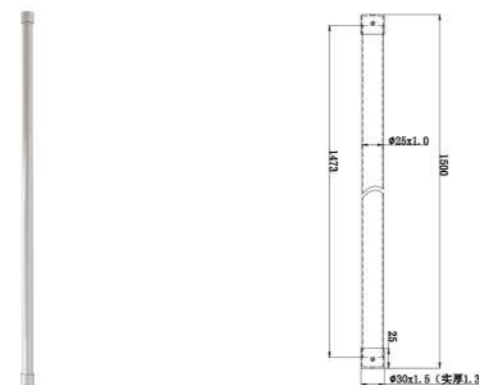

不锈钢浴帘直杆

管型 Tube Type : 25mm圆管

尺寸 Size: 1500*25 mm

材质 Material: 304不锈钢

表面 Colour : 砂光、镜光

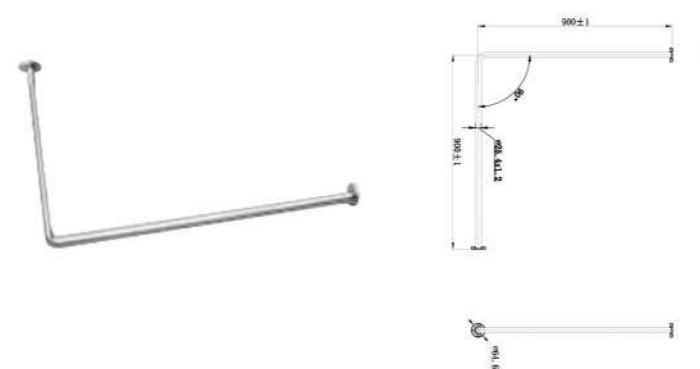

不锈钢浴帘L型杆

管型 Tube Type : 25mm圆管

尺寸 Size: 900*900*25 mm

材质 Material: 304不锈钢

表面 Colour : 砂光、镜光

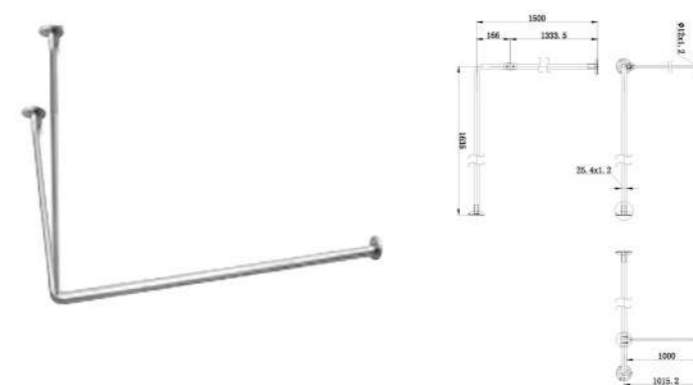

不锈钢浴帘L型杆(带辅助杆)

管型 Tube Type : 25mm圆管

尺寸 Size: 900*900*25 mm

材质 Material: 304不锈钢

表面 Colour : 砂光、镜光



不锈钢弧形浴帘杆

管型 Tube Type: 25mm圆管

尺寸 Size: 60英寸 72英寸 或其他长度

材质 Material: 304不锈钢

表面 Colour: 砂光、镜光



JA10
Single robe hook
衣钩

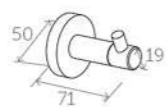

JA11
Double robe hook
双衣钩

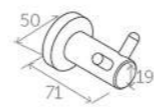

JB11
Single robe hook
衣钩

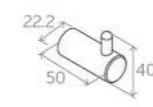

JB12
Double robe hook
双衣钩

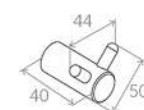

JD11
Double robe hook
双衣钩

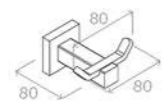

JD10
Single robe hook
衣钩

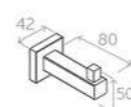

JD11
Double robe hook
双衣钩

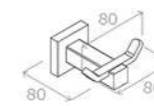

JE10
Robe hook
袍钩

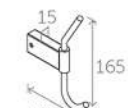

JI10
Robe hook
衣钩



JL10
Robe hook
衣钩

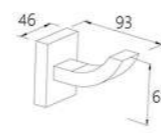

JJ10
Robe hook
衣钩

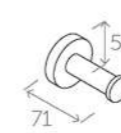

JK11
Double robe hook
衣钩

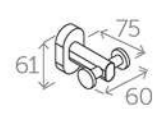

JM05
Robe hook
衣钩

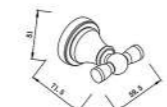

JT11
Robe Hook
挂钩

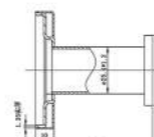

JT12
Robe Hook
衣钩

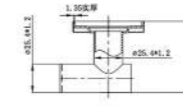

JW08
Single robe hook
单衣钩

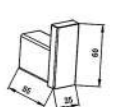

JW09
Double Robe Hook
双衣钩



JY10
Single robe hook
单衣钩

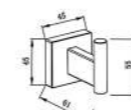

JY11
Double Robe Hook
双衣钩



JZ10
Single robe hook
单衣钩



JZ11
Double Robe Hook
双衣钩

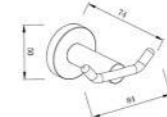

JZ13
Single robe hook
单衣钩



ZFF6
Single robe hook
单衣钩



ZFG6
Single robe hook
单衣钩

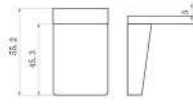



ZFZ1-D
125*43*20
方形双头衣钩



JH03
V-shape clothes hook
V形排衣钩



ZFZ2-D
190*43*20
方形三头衣钩



JH05
Clothes hook
小V形排衣钩



ZFZ3-D
275*43*20
方形四头衣钩



JH01
Clothes hook
扁方排衣钩



ZFZ4-D
360*43*20
方形五头衣钩



JH04
Straight column clothes hook
直柱形排衣钩



JA01
Single towel bar
单杆



JB01
Single towel bar
单杆



JD01
Single towel bar
单杆

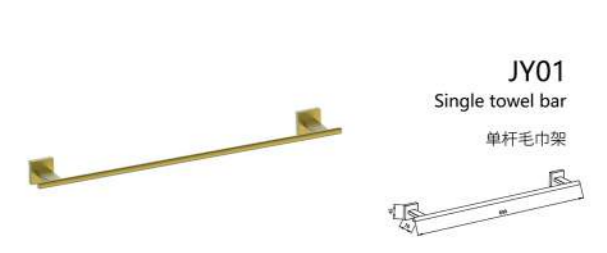

JY01
Single towel bar
单杆毛巾架



JE01
Single towel bar
单杆



JI01
Single towel bar
单杆



JJ01
Single towel bar
单杆



JZ01
Single towel bar
单杆毛巾架



JK01
Towel bar
单杆



JL01
Towel bar
单杆

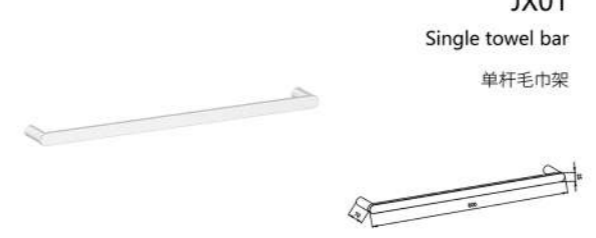

JX01
Single towel bar
单杆毛巾架



JM01
Single towel bar
单杆毛巾架



JW01
Single towel bar
单杆毛巾架



JT01
Single towel bar
单杆

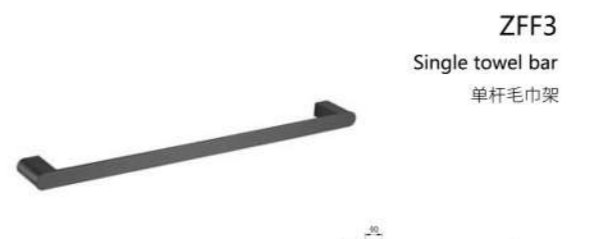

ZFF3
Single towel bar
单杆毛巾架



ZFG3
Single towel bar
单杆毛巾架



JA05
Roll paper holder
纸巾架

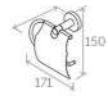

JB05
Roll paper holder
纸巾架

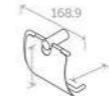

JD05
Paper holder with cover
纸巾架

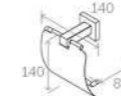

JJ05
Paper holder with cover
纸巾架



JT06
Paper holder
纸巾架 (带盖)

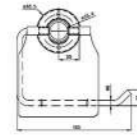

JK05
Roll paper holder
纸巾架

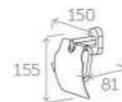

JM10
Roll paper holder
纸巾架 (带盖)

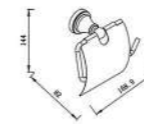

JZ05
Paper holder
带盖纸巾架



JM11
Paper holder
纸巾架

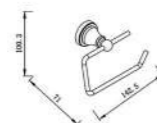

JT05
Paper holder
纸巾架

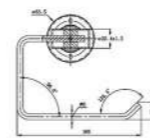

JE05
Paper holder
纸巾钩



JK07
Paper holder
纸巾钩



JT07
Toilet Paper Holder
单边卷纸架

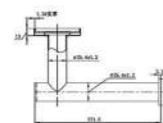

JZ06
Paper holder
单纸巾架



JY06
Paper holder
单纸巾架



JX05
Paper holder
厕纸架



JW05
Paper holder
厕纸架



JL05
Roll paper holder
纸巾架

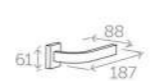

JT08
Double Toilet Paper Holder
T型卷纸架

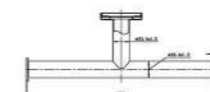

JY05
Paper holder
双纸巾架

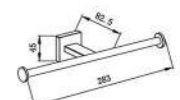



JJ06
Paper towel hook
备用纸巾架

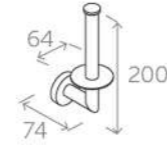

JZ07
Paper holder
双纸架

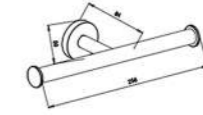

JT09
Toilet Paper Holder
卷纸架

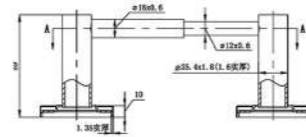

JT10
Double Toilet
Paper Holder
双卷纸架

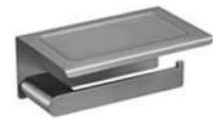
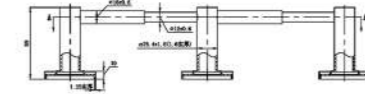

ZFF8-Q
带置物厕纸架
Paper Holder with cover
200*120*80mm

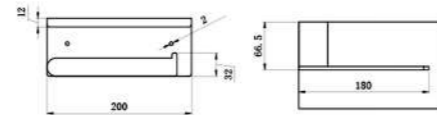

ZFG8S
带置物双纸巾架
Double Paper Holder with cover
280*100*80mm

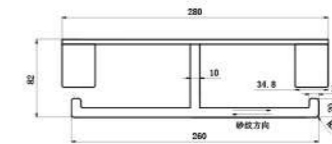

ZFG8
带置物纸巾架
Paper towel holder with slot
200*100*80mm

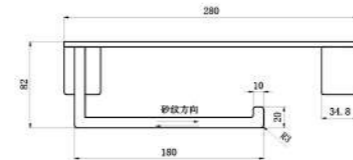

ZFG5
厕纸架
Roll Paper Holder
180*50*50mm

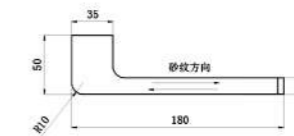

ZFF5-Q
厕纸架
Roll Paper Holder
180*65*32mm

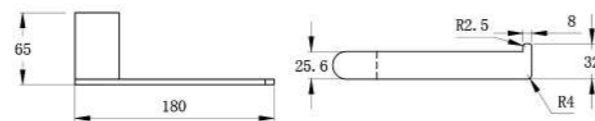

ZFF9-Q
毛巾环
Towel Ring
250*65*32mm

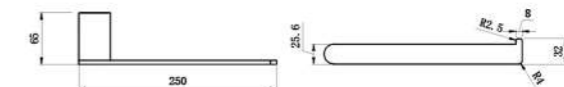



JA12
Toilet brush holder
马桶刷



JD12
Toilet brush holder
马桶刷



JI12
Toilet brush holder
马桶刷



JJ12
Toilet brush holder
马桶刷



JK12
Toilet brush holder
马桶刷



JL12
Toilet brush holder
马桶刷



JM12
Toilet brush holder
马桶刷



JE12
Toilet brush holder
马桶刷

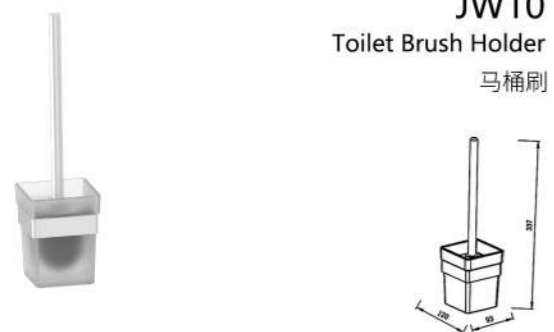
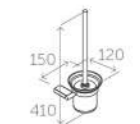

JW10
Toilet Brush Holder
马桶刷

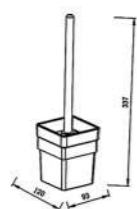

JX09
Toilet Brush Holder
马桶刷

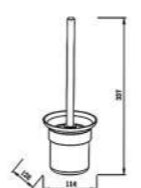

JY12
Toilet Brush Holder
马桶刷

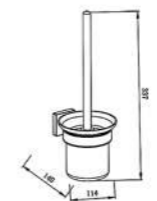

JZ12
Toilet Brush Holder
马桶刷

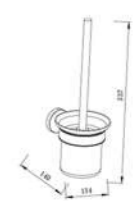

ZFG4
Toilet Brush Holder
马桶刷

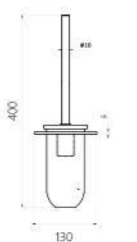

ZFF4
Toilet Brush Holder
马桶刷

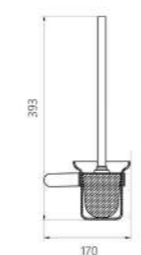

JA16
Toilet brush holder (round)
马桶刷(圆形)



JD16
Toilet brush holder (square)
马桶刷(正方形)

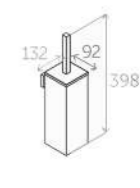



JC01
Basket
置物篮



ZFS5-D
275*275*370
双层角网篮



JC02
Soap holder
肥皂架



JC03
Storage basket
置物篮



JC04
Basket
置物篮



JC05
Basket
置物篮

JN01

Floor Standing Bathroom Accessory

落地挂件

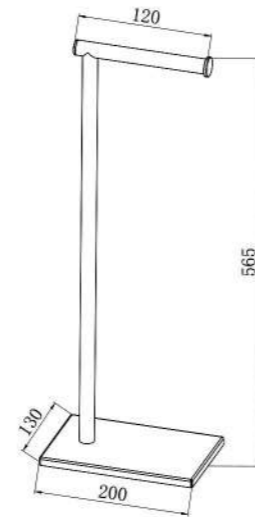

JN02

Floor Standing Bathroom Accessory

落地挂件

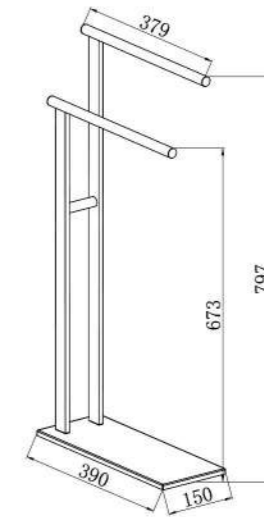

JN03

Floor Standing Bathroom Accessory

落地挂件

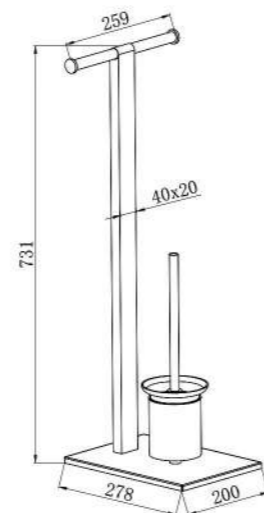
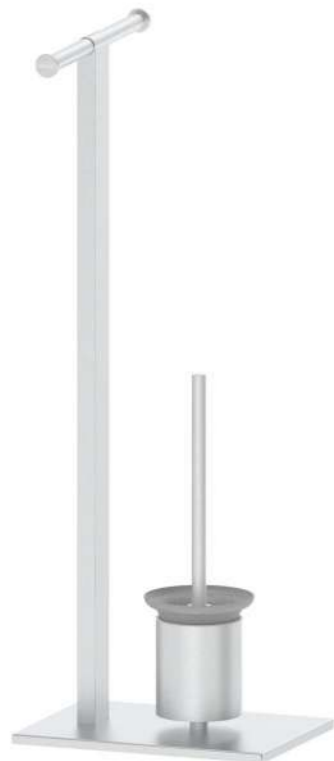

JN04

Floor Standing Bathroom Accessory

落地挂件

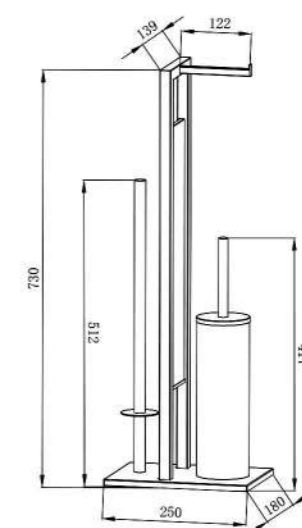

淋浴房拉手-标准款



名称：对装拉手
 材质：SUS304
 管径： $\Phi 25 \times 10$
 管厚：1.0 mm
 规格：380mm
 表面：镜光、拉丝、PVD颜色

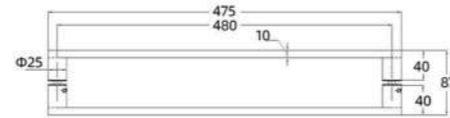

名称：拉手
 材质：SUS304
 管径： $\Phi 25 \times 10$
 管厚：1.0 mm
 规格：孔距305mm
 表面：镜光、拉丝、PVD颜色

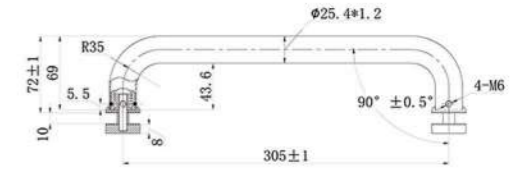

名称：对装拉手
 材质：SUS304
 管径： $\Phi 20 \times 10$
 管厚：1.0 mm
 规格：380mm
 表面：镜光、拉丝、PVD颜色

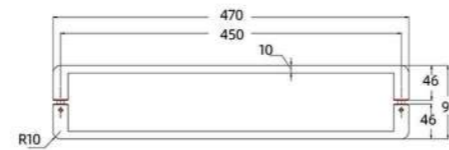

名称：单边小拉手带抓把头
 材质：SUS304
 管径： $\Phi 25 \times 10$
 管厚：1.0mm
 规格：孔距145mm
 表面：镜光、拉丝、PVD颜色

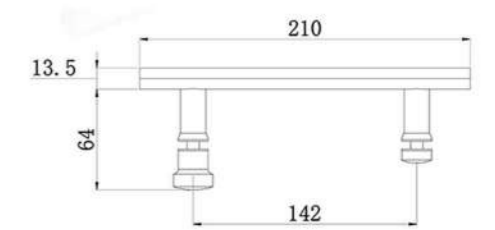

名称：对装拉手
 材质：SUS304
 管径： $\Phi 25$
 管厚：0.8mm
 规格：425*275mm
 表面：镜光、拉丝、PVD颜色

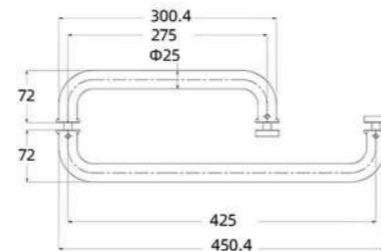

名称：拉手
 材质：SUS304
 管径： $\Phi 25 \times 10$
 管厚：1.0 mm
 规格：孔距305mm
 表面：镜光、拉丝、PVD颜色

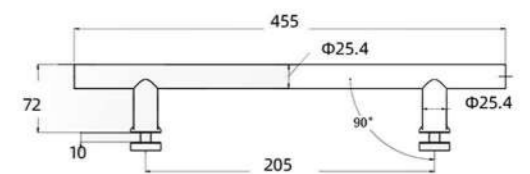

浴缸拉手系列-标准款



材质 : SS304
 直径 : $\phi 19.1 \times 1.0 \text{ mm}$
 尺寸 : C305.00 mm
 高度 : 41.50 mm
 表面 : 砂光

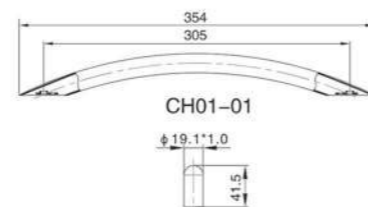

材质 : SS304
 直径 : $\phi 35.3 \times 23.6 \times 1.2 \text{ mm}$
 尺寸 : C547.40 mm
 高度 : 56.50 mm
 表面 : 砂光

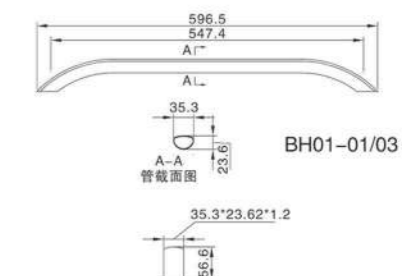

材质 : SS304
 直径 : $\phi 28.6 \times 1.0 \text{ mm}$
 尺寸 : C570.00 mm
 高度 : 65.00 mm
 表面 : 砂光

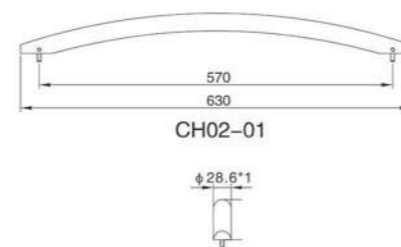

材质 : SS304
 直径 : $\phi 25.4 \times 1.0 \text{ mm}$
 尺寸 : C455.00 mm
 高度 : 75.30 mm
 表面 : 砂光

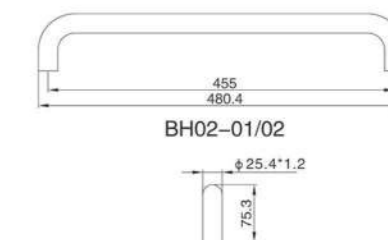

浴缸拉手系列-标准款



材质 :SS304
 直径 : ϕ 28.6x1.0mm
 尺寸 :C570.00 mm.
 高度 :65.00 mm
 表面 :砂光

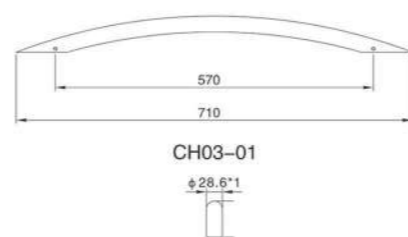

CH03-01



材质 :SS304
 直径 : ϕ 35.3x23.6x1.2 mm
 尺寸 :C547.40 mm.
 高度 :56.50 mm
 表面 :黑色喷粉

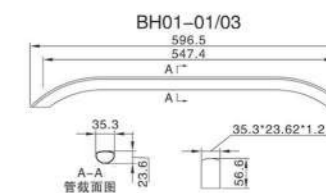

BH01-01/03



材质 :SS304
 直径 : ϕ 31.8x1.2mm
 尺寸 :C508.8.00 mm.
 高度 :127.00mm
 表面 :砂光

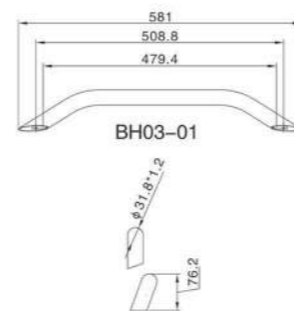

BH03-01



材质 :SS304
 直径 : ϕ 30.00 x15.00 x1.0mm
 尺寸 :448.5C.
 高度 :45 mm
 表面 :砂光

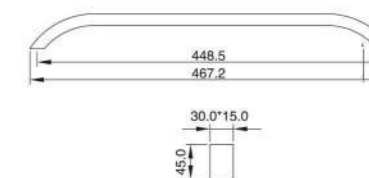

30.0*15.0

玻璃门拉手系列-标准款



材质 : SS304
 直径 : $\phi 25.4 \times 1.0$ mm
 尺寸 : C455.00 mm.
 高度 : 65.00 mm
 表面 : 砂光

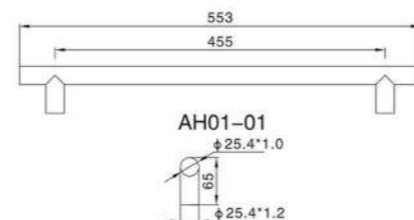

材质 : SS304
 直径 : $\phi 19 \times 1.0$ mm ($\phi 22, \phi 25$)
 尺寸 : C370.00 mm.
 高度 : 46.50mm / 49.50mm / 52.50mm
 表面 : 砂光

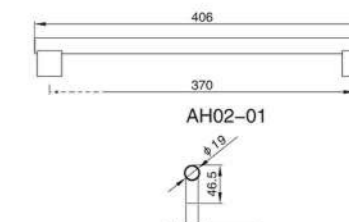

材质 : SS304
 直径 : $\phi 30 \times 15$ mm
 尺寸 : C374.00 mm.
 高度 : 43.00 mm
 表面 : 砂光

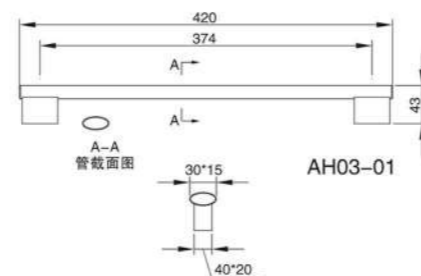

材质 : SS304
 直径 : $\phi 33 \times 20 \times 1.0$ mm
 尺寸 : C450.00 mm.
 高度 : 48.00 mm
 表面 : 砂光

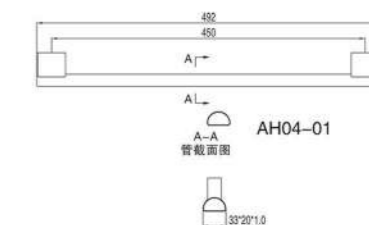

SQUARE FLOOR DRAIN
SERIES

•
方形地漏系列



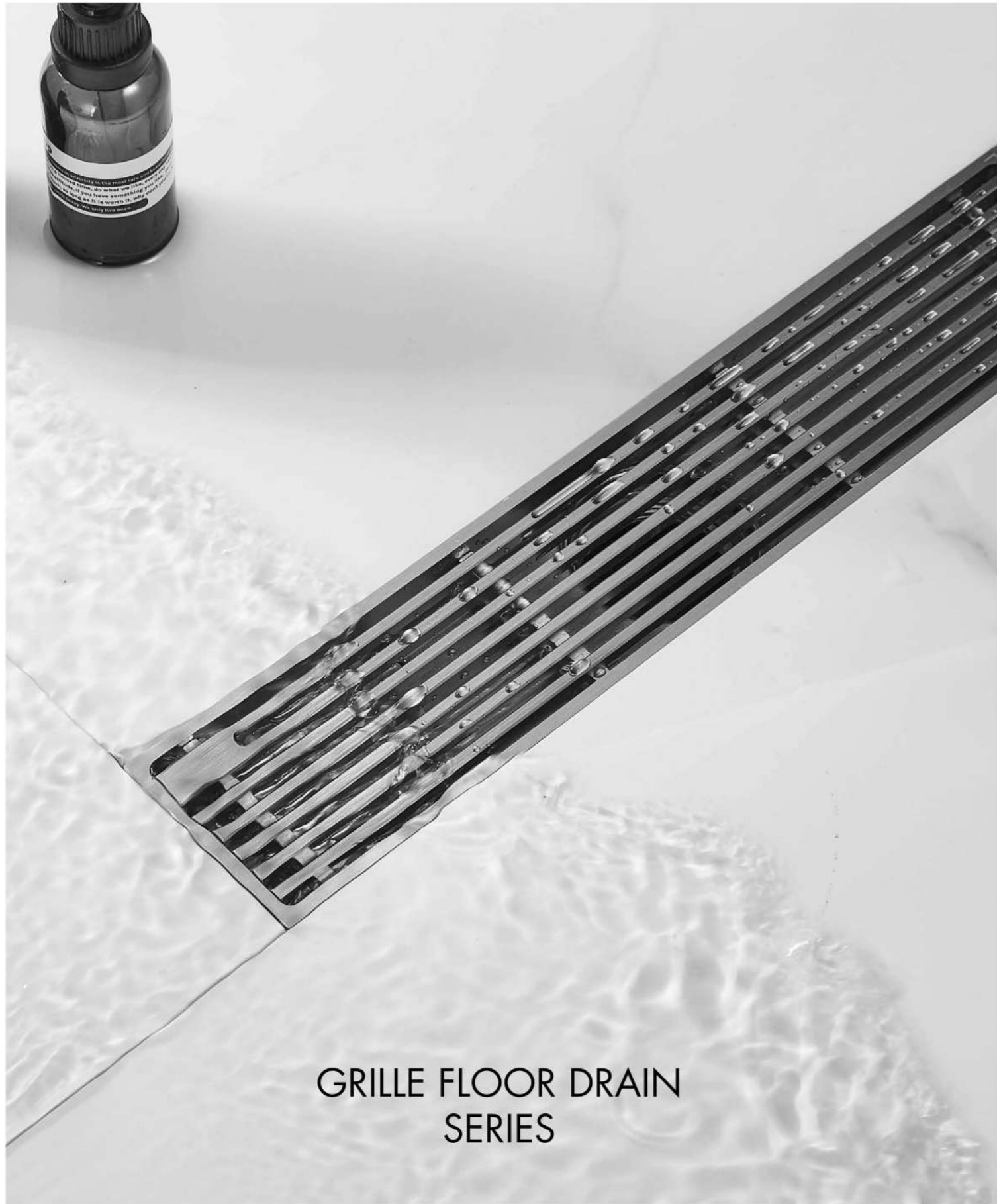

GRILLE FLOOR DRAIN
SERIES



ACCESSIBLE FLOOR DRAIN SERIES

不锈钢方形地漏



ZDC1

产品名称：方形地漏
 产品材质：SUS304, SUS316
 产品颜色：镀铬 / 砂镍 / 枪灰
 产品尺寸：100*100*4mm

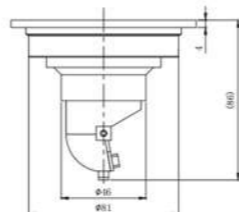

ZDC2

产品名称：方形地漏
 产品材质：SUS304, SUS316
 产品颜色：镀铬 / 砂镍 / 枪灰
 产品尺寸：100*100*4mm

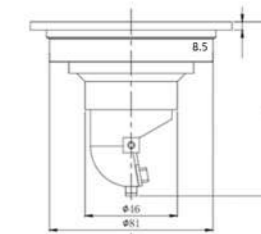

ZDC3

产品名称：方形地漏
 产品材质：SUS304, SUS316
 产品颜色：镀铬 / 砂镍 / 枪灰
 产品尺寸：100*100*8.5mm

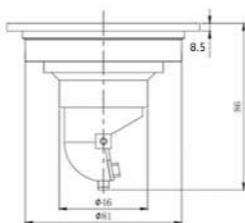

ZDC4

产品名称：方形地漏
 产品材质：SUS304, SUS316
 产品颜色：镀铬 / 砂镍 / 枪灰
 产品尺寸：100*100*9mm

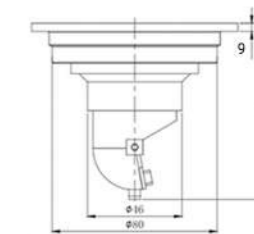

ZDD1

产品名称：洗衣机地漏
 产品材质：SUS304, SUS316
 产品颜色：镀铬 / 砂镍 / 枪灰
 产品尺寸：100*100*4mm

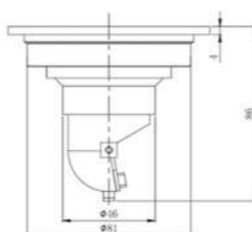

ZDD2

产品名称：洗衣机地漏
 产品材质：SUS304, SUS316
 产品颜色：镀铬 / 砂镍 / 枪灰
 产品尺寸：100*100*8.5mm

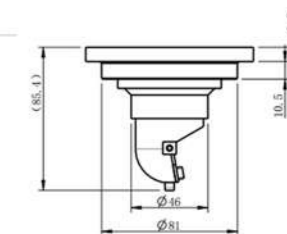

不锈钢方形地漏



ZDA1P

产品名称：隐形地漏
产品材质：SUS304, SUS316
产品颜色：砂镍 / 枪灰
产品尺寸：100*100*18mm



滑动设计



ZDA1-80

产品名称：干区地漏
产品材质：SUS304, SUS316
产品颜色：拉丝封油 / 拉丝枪灰
产品尺寸：80*80*26mm



推荐



磁悬浮地漏芯

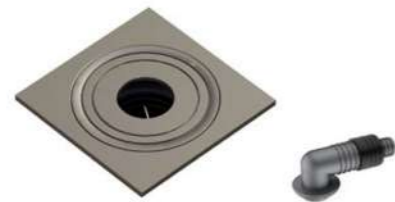

ZDD3

产品名称：洗衣机地漏
产品材质：SUS304, SUS316
产品颜色：镀铬 / 砂镍 / 枪灰
产品尺寸：100*100*4mm



ZDC6

产品名称：弹跳地漏
产品材质：SUS304, SUS316
产品颜色：镀铬
产品尺寸：100*100*4mm



ZDC7-80

产品名称：方形地漏
产品材质：SUS304, SUS316
产品颜色：镀铬 / 砂镍 / 枪灰
产品尺寸：80*80*9mm



ZDA1

产品名称：方形地漏
产品材质：SUS304, SUS316
产品颜色：镀铬 / 砂镍 / 枪灰
产品尺寸：100*100*18mm

不锈钢格栅地漏



ZDE3

产品名称: 300 全铜格栅地漏
产品材质: SUS304, SUS316
产品颜色: 枪灰 / 砂镍
产品尺寸: 300*80*18mm



ZDE4

产品名称: 300/600 全铜格栅地漏
产品材质: SUS304, SUS316
产品颜色: 枪灰 / 砂镍
产品尺寸: 300*58*18mm / 600*58*18mm



ZDE5

产品名称: 300 不锈钢格栅地漏
产品材质: SUS304, SUS316
产品颜色: 砂光 / 拉丝枪灰
产品尺寸: 300*57*18mm



ZDE6

产品名称: 200 全铜格栅地漏
产品材质: SUS304, SUS316
产品颜色: 枪灰 / 砂镍
产品尺寸: 200*82*10mm

不锈钢格栅地漏

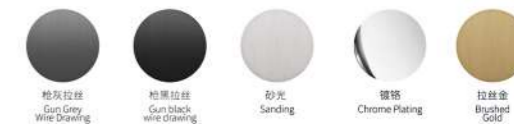

ZDF1

产品名称：格栅款一字型无障碍地漏
产品材质：SUS304, SUS316
产品颜色：砂光 / 枪灰 / 枪黑 / 拉丝金
产品尺寸：非标定制



ZDG1

产品名称：隐形款一字型无障碍地漏
产品材质：SUS304, SUS316
产品颜色：砂光 / 枪灰 / 枪黑 / 拉丝金
产品尺寸：非标定制



ZDF3

产品名称：格栅款 L 型无障碍地漏
产品材质：SUS304, SUS316
产品颜色：砂光 / 枪灰 / 枪黑 / 拉丝金
产品尺寸：非标定制



ZDH1

产品名称：格栅款钻石型无障碍地漏
产品材质：SUS304, SUS316
产品颜色：砂光 / 枪灰 / 枪黑 / 拉丝金
产品尺寸：非标定制

不锈钢线性地漏



ZGM1

产品名称: 墙排地漏 (非标定制)
产品材质: SUS304, SUS316
产品颜色: 砂光 / 枪灰 / 拉丝金
产品尺寸: 900*35*40mm



ZDA4

产品名称: 55 宽隐形不锈钢地漏
产品材质: SUS304, SUS316
产品颜色: 拉丝金 / 砂光 / 枪灰
产品尺寸: 55*300*28mm / 55*600*28mm
55*800*28mm



ZDB4

产品名称: 线形 04 款砂光地漏
产品材质: SUS304, SUS316
产品颜色: 砂光 / 枪灰 / 拉丝金
产品尺寸: 32*600*28mm / 32*800*28mm



ZDA5

产品名称: 隐形全铜地漏
产品材质: SUS304, SUS316
产品颜色: 砂镍 / 枪灰
产品尺寸: 58*300*20mm / 58*600*20mm



灵动设计



ZDB10

产品名称: 线形 10 款全铜地漏
产品材质: SUS304, SUS316
产品颜色: 砂镍 / 枪灰
产品尺寸: 30*600*25*3.0mm / 30*800*25*3.0mm



ZDA6

产品名称: 隐形全铜地漏
产品材质: SUS304, SUS316
产品颜色: 砂镍 / 枪灰
产品尺寸: 35*600*20mm



灵动设计

不锈钢线性地漏



ZDB1

产品名称: 线形 01 款不锈钢地漏
产品材质: SUS304, SUS316
产品颜色: 砂光 / 拉丝枪灰 / 拉丝金
产品尺寸: 35*600*28*2.3mm
35*800*28*2.3mm



ZDB8

产品名称: 线形 08 款不锈钢地漏
产品材质: SUS304, SUS316
产品颜色: 砂光 / 拉丝枪灰 / 拉丝金
产品尺寸: 32*600*23*3.0mm
32*800*23*3.0mm



ZDB6

产品名称: 线形 06 款不锈钢地漏
产品材质: SUS304, SUS316
产品颜色: 砂光 / 拉丝枪灰 / 拉丝金
产品尺寸: 32*600*27.5*3.0mm
32*800*27.5*3.0mm



ZDB9

产品名称: 线形 09 款不锈钢地漏
产品材质: SUS304, SUS316
产品颜色: 砂光 / 拉丝枪灰 / 拉丝金
产品尺寸: 44*624.6*35*2.4mm
44*824.6*35*2.4mm



ZDB7

产品名称: 线形 07 款不锈钢地漏
产品材质: SUS304, SUS316
产品颜色: 砂光 / 拉丝枪灰 / 拉丝金
产品尺寸: 32*600*16*3.0mm
32*800*16*3.0mm



ZDB11

产品名称: 线形 11 款不锈钢地漏
产品材质: SUS304, SUS316
产品颜色: 砂光 / 拉丝枪灰 / 拉丝金
产品尺寸: 32*600*27*3.0mm
32*800*27*3.0mm

不锈钢工程地漏



ZLB-01-05

正方形地漏
133*133*80高*2/1.25



ZTB-01-13

三角形地漏
359*254*182*80高*2/1.25



ZLY-01-05

正方形地漏
133*133*85高*2/1.25



ZLY-01-13

三角形地漏
359*254*182*80高*2/1.25



LVA050504

正方形地漏
133*133*85高*2/1.25



LVA131004

三角形地漏
359*254*182*80高*2/1.25

不锈钢工程地漏



ZBE360304

L型地漏
915*915*80高*1.25



ZLB-01-12

长形地漏
长: 305/610/813/915/1200/1500mm



ZYE360304

L型地漏
915*915*80高*1.25



ZLW-01-24

长形地漏
长: 305/610/813/915/1200/1500mm



ZVA360304

L型地漏
915*915*80高*1.25



ZLV-01-32

长形地漏
长: 305/610/813/915/1200/1500mm

更多颜色材质供您选择

支持定制颜色、尺寸

支持来图来样设计生产，详询业务人员



砂光 (Satin)

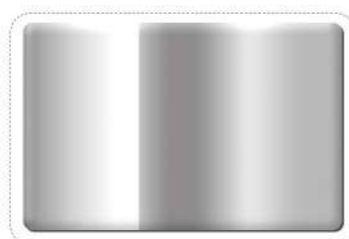

镜光 (Polished)



砂镍 (Brushed nickel)

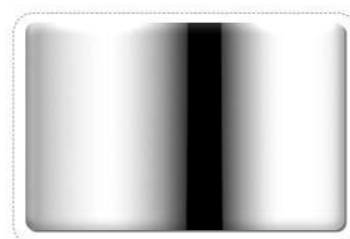

镀铬 (chromate treatment)



雅白 (White)



枪灰拉丝 (Brushed gun gray)



枪黑拉丝 (Brushed Black)



雅黑 (Matte Black)



油渍青铜 (Oil rubbed bronze)

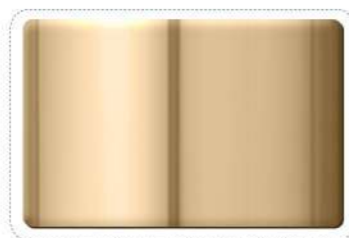

钛金 (Gold)



拉丝黄铜 (Brushed Brass)

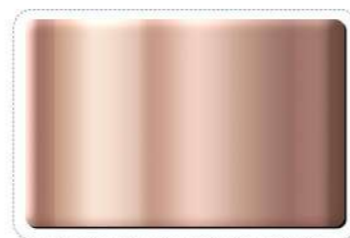

玫瑰金 (Rose golden)

卫浴五金产品 COMBINED CABINET



喷粉白色



电镀枪灰



喷粉黑色



砂光



电镀玫瑰金



电镀拉丝金

商用不锈钢纸巾盒



名称：置物卷纸纸巾箱
材质：不锈钢304
规格：275*291*126mm
板厚：0.7mm/1.2mm
表面：镜光、砂光、多颜色定制
安装：明装

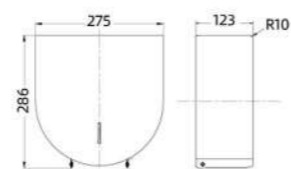

名称：擦手纸巾箱
材质：不锈钢304
规格：282*265*101.5mm
板厚：0.7mm/1.2mm
表面：镜光、砂光、多颜色定制
安装：明装

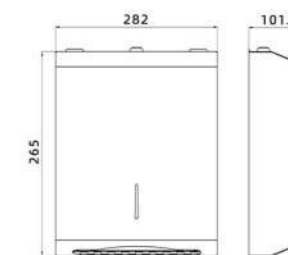

名称：坐厕纸箱
材质：不锈钢304/201
规格：310*210*45mm
板厚：0.7mm/1.2mm
表面：镜光、砂光、多颜色定制
安装：明装

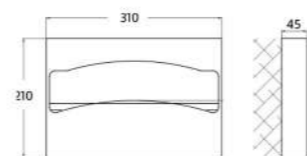

名称：坐厕纸箱
材质：不锈钢304/201
规格：400*285*45mm
板厚：0.7mm/1.2mm
表面：镜光、砂光、多颜色定制
安装：明装

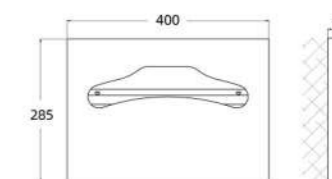

商用不锈钢纸巾盒



名称：不锈钢带锁卷纸箱
材质：不锈钢304
尺寸：265*260*118mm
板厚：1.2mm
表面：镜光、砂光、多颜色定制
安装：明装

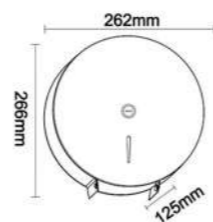

名称：盘纸纸巾箱
材质：不锈钢304
规格：262*266*125mm
板厚：0.7mm/1.2mm
表面：镜光、砂光、多颜色定制
安装：明装

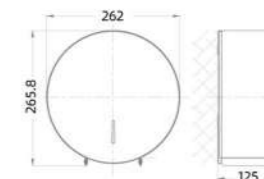

名称：KA03-01带置物架
材质：不锈钢304/201
规格：4 262*270*125*0.7mm
板厚：0.7mm/门板1.2mm
表面：镜光、砂光、多颜色定制
安装：明装

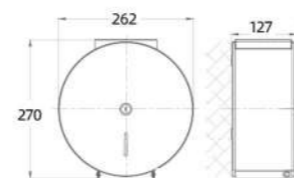

名称：不锈钢垃圾箱
材质：不锈钢304
尺寸：600*400*195mm
板厚：0.7mm/1.2mm
表面：镜光、砂光
安装：明装

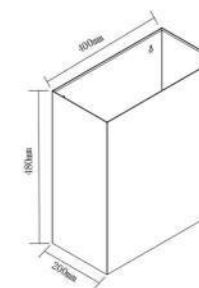

不锈钢垃圾收纳口



名称：LC01-01/垃圾收纳圆形上口
材质：不锈钢304
规格： $\phi 190*80\text{mm}$
板厚：0.7mm/1.2mm
表面：砂光、镜光、多颜色定制
安装：明装

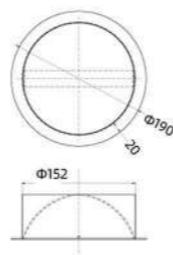

名称：LC01-01/垃圾收纳圆形上口
材质：不锈钢304
规格： $\phi 190*80\text{mm}$
板厚：0.7mm/1.2mm
表面：砂光、镜光、多颜色定制
安装：明装

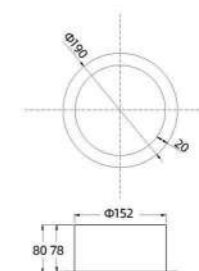

名称：LB01-01/垃圾收纳方形上口
材质：不锈钢304
规格：255*255*125mm
板厚：0.7mm/1.2mm
表面：镜光、砂光、多颜色定制
安装：明装

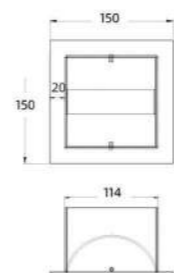

名称：LB01-01/垃圾收纳方形上口
材质：不锈钢304
规格：255*255*125mm
板厚：0.7mm/1.2mm
表面：镜光、砂光、多颜色定制
安装：明装



镜后不锈钢纸巾盒



名称：挂墙式镜后擦手纸巾
材质：不锈钢304
规格：365*280*100mm
板厚：0.7mm/1.2mm
表面：镜光、砂光、多颜色定制
安装：镜后安装



名称：挂墙式镜后箱平口
材质：不锈钢304
规格：365*280*100mm
板厚：0.7mm/1.2mm
表面：镜光、砂光、多颜色定制
安装：镜后安装

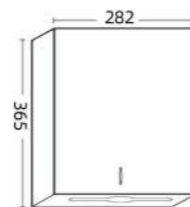

名称：镜后抽巾箱
材质：不锈钢304/201
规格：260*250*100*0.7mm
板厚：0.7mm
表面：砂光
安装：镜后安装

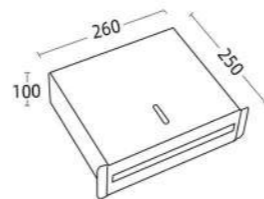

名称：镜后抽巾箱
材质：不锈钢304
规格：300*270*100*0.7mm
板厚：0.7mm
表面：砂光
安装：镜后安装

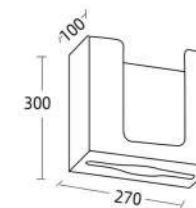

名称：镜后擦手纸箱（带轨道）
材质：不锈钢304
尺寸：505*268*94.6mm
板厚：0.7mm/1.2mm
表面：镜光、砂光
安装：镜后安装

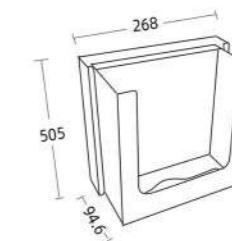

名称：镜后抽拉纸巾箱
材质：不锈钢304
规格：270*390*100*0.7mm
板厚：0.7mm
表面：砂光
安装：镜后安装

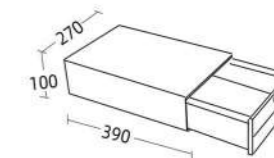

不锈钢抽纸盒



名称：不锈钢抽袋盒 (NB02)

材质：不锈钢304

尺寸：135*95*25mm

板厚：1.0mm

表面：镜光、砂光、多颜色定制

安装：明装

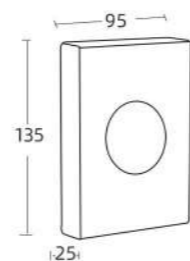

镜后不锈钢二合一纸巾盒/感应皂液器



名称：镜后感应皂液器

材质：不锈钢304

尺寸：183*270*110mm

容量：1000ml

板厚：1.0mm

表面：砂光

安装：镜后安装

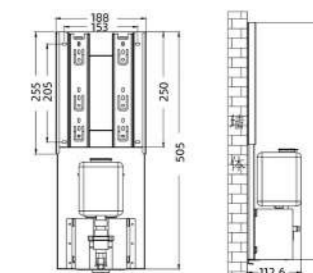

名称：不锈钢抽纸架 (NC01)

材质：不锈钢304

尺寸：260*120*115mm

板厚：1.35实厚

表面：镜光、砂光、多颜色定制

安装：明装

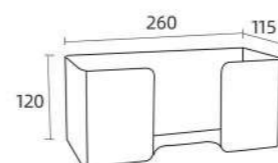

名称：镜后二合一感应皂液器

材质：不锈钢304

规格：476.5*90*300mm

板厚：1.0mm

表面：砂光

安装：镜后安装

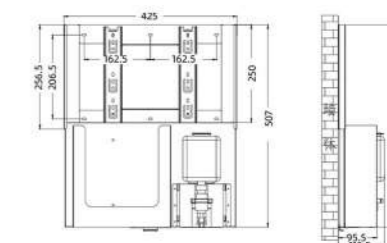

名称：不锈钢卷纸架 (NC02)

材质：不锈钢304

尺寸：125*125*300mm

板厚：1.5mm

表面：镜光、砂光、多颜色定制

安装：明装

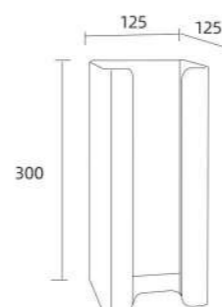

名称：镜后三合一感应皂液器

材质：不锈钢304

规格：650*400*120mm

板厚：1.2mm

表面：砂光

安装：镜后安装



不锈钢按压皂液器



名称：手动按压皂液器(MA01)
材质：不锈钢304
容量：500ML/800ML/
1000ML/1200ML
板厚：0.7mm/1.2mm
表面：镜光、砂光、多颜色定制
安装：明装



名称：手动按压皂液器
材质：不锈钢304
容量：500ML/800ML/
1000ML/1200ML
板厚：0.7mm/1.2mm
表面：镜光、砂光、多颜色定制
安装：明装



名称：手动按压皂液器(MB01)
材质：不锈钢304
容量：500ML/800ML/
1000ML/1200ML
板厚：0.7mm/1.2mm
表面：镜光、砂光、多颜色定制
安装：明装



名称：手动按压皂液器(MC03)
材质：不锈钢304
容量：500ML/800ML/
1000ML/1200ML
板厚：0.7mm/1.2mm
表面：镜光、砂光、多颜色定制
安装：明装

不锈钢按压/感应皂液器



名称：手动按压皂液器
材质：不锈钢304
容量：500ML/800ML/
1000ML/1200ML
板厚：0.7mm/1.2mm
表面：镜光、砂光、多颜色定制
安装：明装



名称：感应皂液器
材质：不锈钢304
尺寸：102*275*93mm
容量：1000ml
板厚：0.7mm/1.2mm
表面：镜光、砂光、多种颜色定制
安装：明装



名称：按压式皂液器
材质：不锈钢304
规格：110*237*83mm
容量：700ML
板厚：0.7mm/1.2mm
表面：镜光、砂光、多颜色定制
安装：明装



名称：FE09-S-280/感应皂液器
材质：不锈钢304/201
规格：280*140*100*0.7mm
板厚：0.7mm
表面：砂光
安装：明装

商用不锈钢组合纸巾箱



名称：HB01-01

材质：不锈钢304/201

规格：1650*370*160mm

板厚：0.7mm/门板1.2mm

表面：镜光、砂光、多颜色定制

安装：暗装/明装

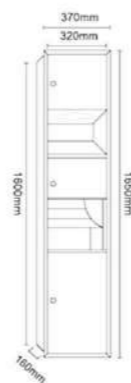

名称：HB02-01

材质：不锈钢304/201

规格：1200*350*160mm

板厚：0.7mm/门板1.2mm

表面：镜光、砂光、多颜色定制

安装：暗装/明装

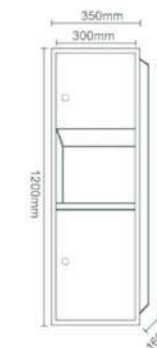

名称：HB03-01

材质：不锈钢304/201

规格：750*310*140mm

板厚：0.7mm/门板1.2mm

表面：镜光、砂光、多颜色定制

安装：暗装/明装

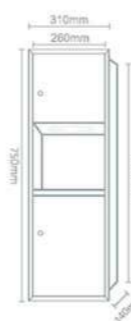

名称：HB04-01

材质：不锈钢304/201

规格：350*165*645mm

板厚：0.7mm/门板1.2mm

表面：镜光、砂光、多颜色定制

安装：暗装/明装



壁龛



ZBA

产品名称: 臻品壁龛
产品尺寸: 305*305*120mm
开孔尺寸: 292*292*120mm

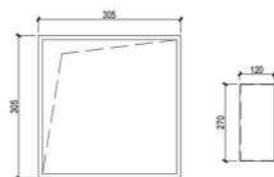

ZBD/ZBDS

产品名称: 臻品壁龛
产品尺寸: 305*610*120mm/266*668*120
开孔尺寸: 292*597*120mm/253*655*120
选加灯 (暖白光 3000K)

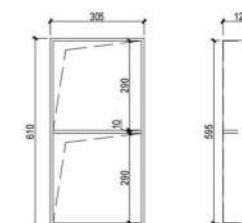

ZBB

产品名称: 臻品壁龛
产品尺寸: 280*1210*120mm
开孔尺寸: 267*1197*120mm
带灯 (暖白光 3000K)

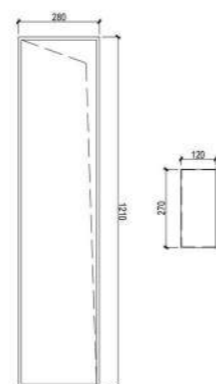

ZBG/ZBGS

产品名称: 臻品壁龛
产品尺寸: 305*1210*120mm/266*998*120
开孔尺寸: 292*1197*120mm/253*985*120
选加灯 (暖白光 3000K)

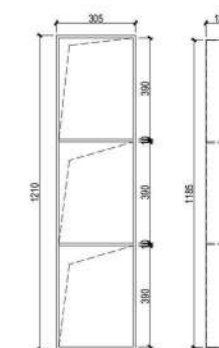



ZBH

产品名称: 臻品壁龛
产品尺寸: 305*1100*120mm
开孔尺寸: 292*1087*120mm
选加灯 (暖白光 3000K)

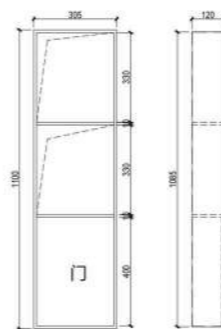

ZBE

产品名称: 臻品壁龛
产品尺寸: 305*1100*120mm
开孔尺寸: 292*1087*120mm
选加灯 (暖白光 3000K)

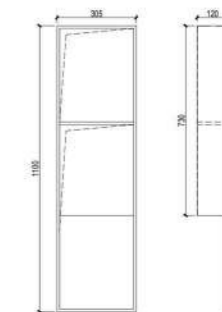

ZBL

产品名称: 三层定制壁龛
产品备注: 选加灯 (暖白光 3000K)



ZBM

产品名称: 四层定制壁龛
产品备注: 选加灯 (暖白光 3000K)





ZBC

产品名称: 臻品壁龛
产品尺寸: 170*230*120mm
开孔尺寸: 157*217*120mm

颜色: 

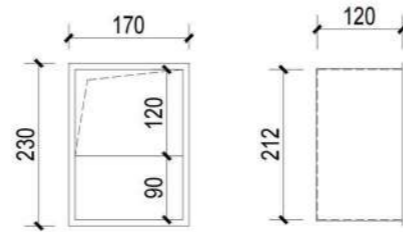

ZBF

产品名称: 臻品壁龛
产品尺寸: 170*600*120mm
开孔尺寸: 157*587*120mm

颜色: 

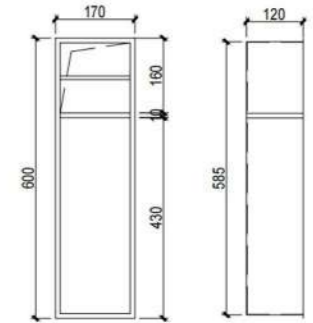

ZBK

产品名称: 臻品壁龛
产品尺寸: 230*600*125mm
开孔尺寸: 217*587*125mm

颜色: 

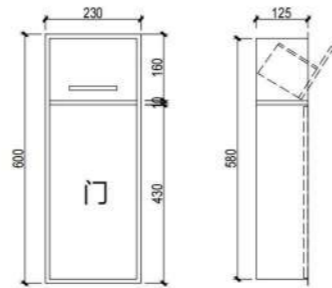

ZBR

产品名称: 定制双层隐形壁龛
产品尺寸: 600*133*160mm
开孔尺寸: 601*134*160mm

颜色: 

OEM定制款

豪华亲肤扶手-标准款



名称：高端直扶手 (SG.001)
材质：SUS304
管径： $\Phi 32$
管厚：1.0 mm、1.2 mm
规格：300mm、450mm、600mm
表面：镜光+喷粉白色+拉包

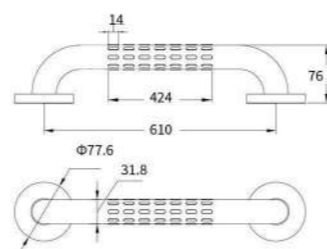

名称：高端135°扶手 (YG.001)
材质：SUS304
管径： $\Phi 32$
管厚：1.0 mm、1.2 mm
规格：300*300mm
表面：镜光+喷粉白色+拉包

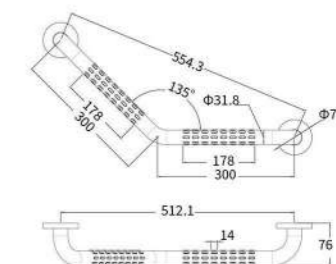

名称：高端L型扶手 (YG.003)
材质：SUS304
管径： $\Phi 32$
管厚：1.0 mm、1.2 mm
规格：600*600mm
表面：镜光+喷粉白色+拉包

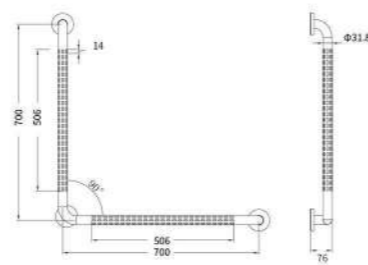

名称：高端大理石台面扶手 (YG.010)
材质：SUS304
管径： $\Phi 32$
管厚：1.0 mm、1.2 mm
规格：600*160mm
表面：镜光+喷粉白色+拉包

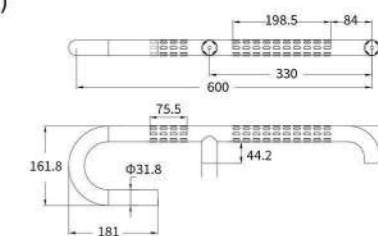

豪华亲肤扶手-标准款



名称：高端防滑洗手台扶手
(YG.024)
材质：SUS304
管径： $\Phi 32$
管厚：1.0 mm、1.2 mm
规格：800mm
表面：镜光+喷粉白色+拉包

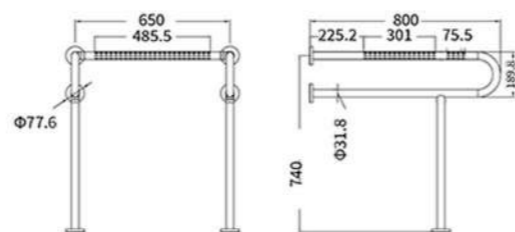

名称：高端防滑上翻扶手
(UG.002)
材质：SUS304
管径： $\Phi 32$
管厚：1.0 mm、1.2 mm
规格：800mm
表面：镜光+喷粉白色+拉包

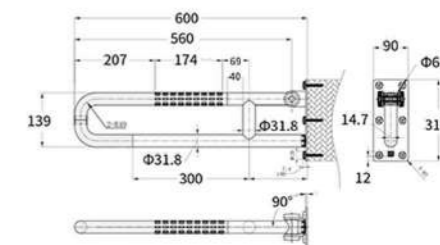

名称：高端防滑小便斗扶手
(YG.027)
材质：SUS304
管径： $\Phi 32$
管厚：1.0 mm、1.2 mm
规格：600*550*490mm
表面：镜光+喷粉白色+拉包

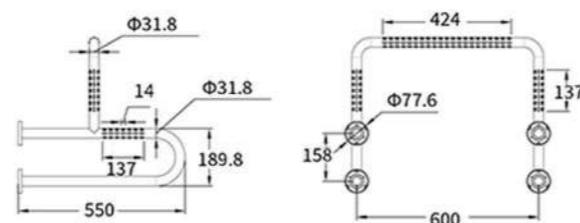

名称：高端防滑单p扶手
(YG.023)
材质：SUS304
管径： $\Phi 32$
管厚：1.0 mm、1.2 mm
规格：800*750mm
表面：镜光+喷粉白色+拉包

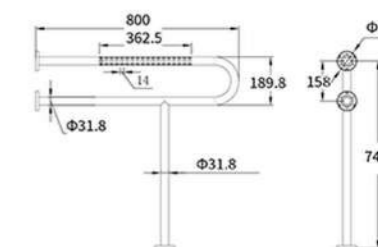

抗菌防滑不锈钢扶手-标准款



名称：抗菌防滑直扶手 (SG.001)
 材质：SUS304
 管径： $\Phi 32$
 管厚：1.0 mm、1.2 mm
 规格：300mm、450mm、600mm
 表面：喷粉黄色、白色

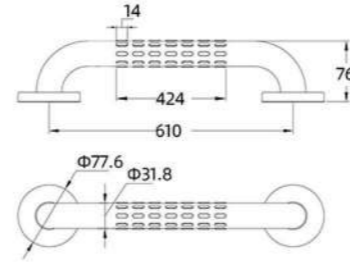

名称：抗菌防滑L型扶手 (YG.004)
 材质：SUS304
 管径： $\Phi 32$
 管厚：1.0 mm、1.2 mm
 规格：600*600mm
 表面：喷粉黄色、白色

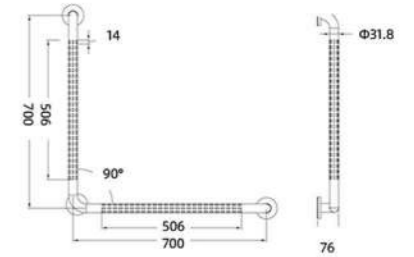

名称：抗菌防滑135°扶手 (YG.001)
 材质：SUS304
 管径： $\Phi 32$
 管厚：1.0 mm、1.2 mm
 规格：300*300mm
 表面：喷粉黄色、白色

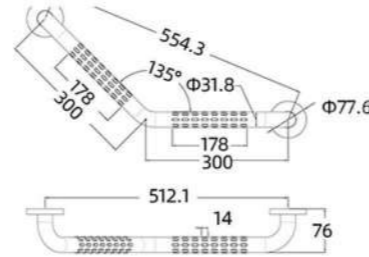

名称：抗菌防滑大理石台扶手 (YG.101)
 材质：SUS304
 管径： $\Phi 32$
 管厚：1.0 mm、1.2 mm
 规格：600mm
 表面：喷粉黄色、白色

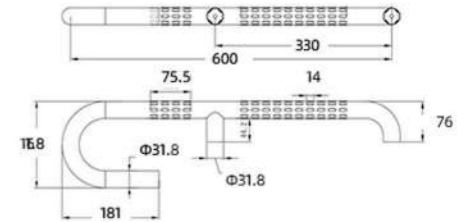

名称：抗菌防滑淋浴扶手 (YG.019)
 材质：SUS304
 管径： $\Phi 32$
 管厚：1.0 mm、1.2 mm
 规格：600*1100mm
 表面：喷粉黄色、白色

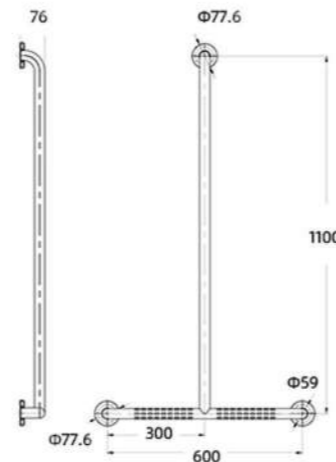

名称：抗菌防滑上翻扶手 (UG.015)
 材质：SUS304
 管径： $\Phi 32$
 管厚：1.0 mm、1.2 mm
 规格：600mm
 表面：喷粉黄色、白色

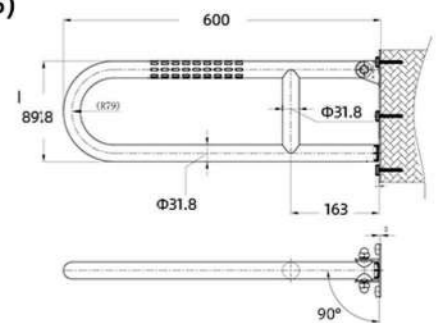

抗菌不锈钢扶手-标准款

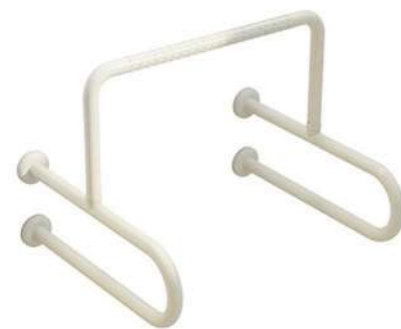

名称：抗菌防滑洗小便斗扶手 (YG.027)

材质：SUS304

管径：φ32

管厚：1.0 mm、1.2 mm

规格：600*550*490mm

表面：喷粉黄色、白色

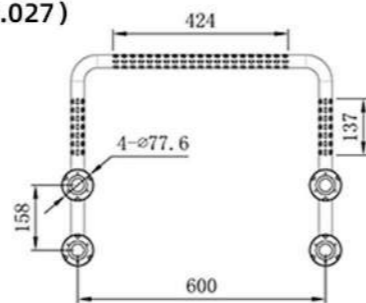

名称：抗菌防滑洗手盆扶手 (YG.026)

材质：SUS304

管径：φ32

管厚：1.0 mm、1.2 mm

规格：600*445mm

表面：喷粉黄色、白色

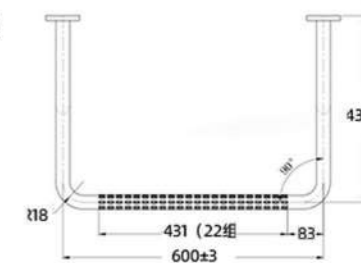

名称：抗菌防滑异形扶手 (YG.011)

材质：SUS304

管径：φ32

管厚：1.0 mm、1.2 mm

规格：838*150*762mm

表面：喷粉黄色、白色

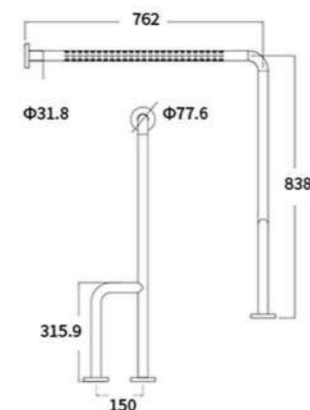

名称：抗菌防滑单边扶手 (YG.023)

材质：SUS304

管径：φ32

管厚：1.0 mm、1.2 mm

规格：800*750mm

表面：喷粉黄色、白色

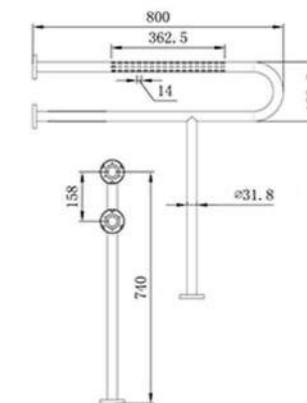

名称：抗菌防滑柱盘扶手 (YG.024)

材质：SUS304

管径：φ32

管厚：1.0 mm、1.2 mm

规格：800*650*780mm

表面：喷粉黄色、白色

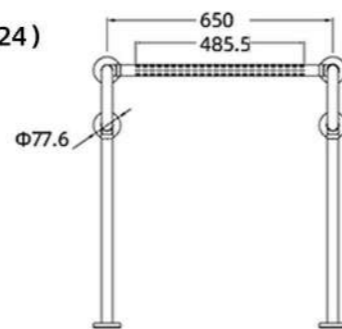

名称：抗菌防滑单边上翻扶手 (UG.015)

材质：SUS304

管径：φ32

管厚：1.0 mm、1.2 mm

规格：800*716mm

表面：喷粉黄色、白色

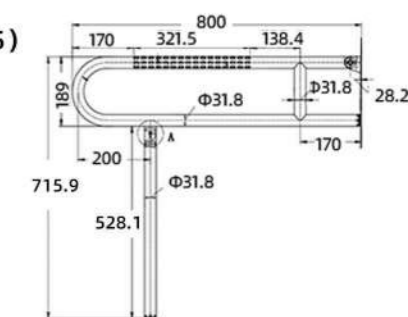

钻石纹不锈钢扶手-标准款



名称：钻石纹防滑直扶手 (SG.001)

材质：SUS304

管径： $\Phi 32$

管厚：1.0 mm、1.2 mm

规格：300mm、460mm、600mm

表面：钻石纹

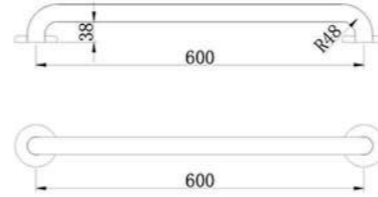

名称：钻石纹防滑135°扶手 (YG.001)

材质：SUS304

管径： $\Phi 32$

管厚：1.0 mm、1.2 mm

规格：300*300mm

表面：钻石纹

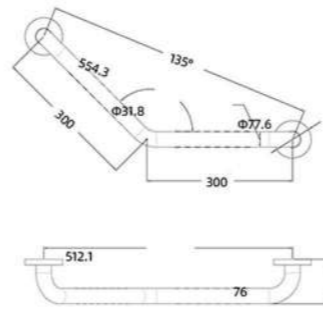

名称：钻石纹防滑小便斗扶手 (YG.027)

材质：SUS304

管径： $\Phi 32$

管厚：1.0 mm、1.2 mm

规格：600*550*490mm

表面：钻石纹

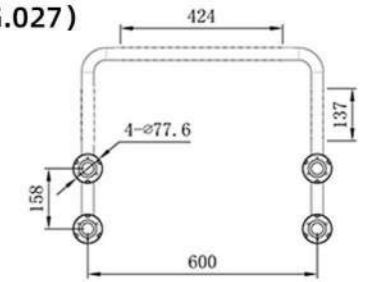

名称：钻石纹防滑柱盘扶手 (YG.024)

材质：SUS304

管径： $\Phi 32$

管厚：1.0 mm、1.2 mm

规格：800*650*780mm

表面：钻石纹

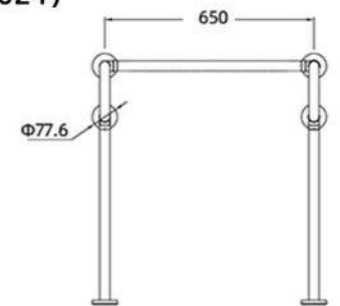

名称：钻石纹防滑L形扶手 (YG.003)

材质：SUS304

管径： $\Phi 32$

管厚：1.0 mm、1.2 mm

规格：400*400mm

表面：钻石纹

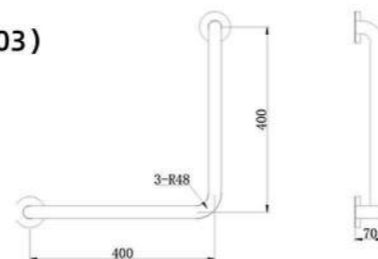

实木-不锈钢扶手-标准款



名称：高端实木不锈钢直扶手 (SG.001)

材质：SUS304+实木
(樟木、柚木、胡桃木)

管径： $\Phi 35$

管厚：1.5 mm

规格：300mm、460mm、600mm

表面：镜光

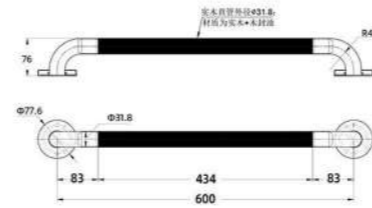

名称：高端实木不锈钢上翻扶手 (UG.001)

材质：SUS304+实木
(樟木、柚木、胡桃木)

管径： $\Phi 35$

管厚：1.5 mm

规格：760mm

表面：镜光

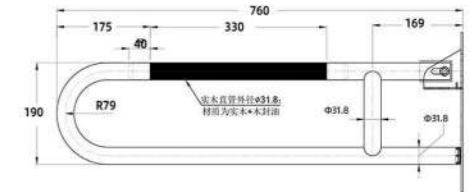

名称：高端实木不锈钢90°扶手 (YG.004)

材质：SUS304+实木
(樟木、柚木、胡桃木)

管径： $\Phi 35$

管厚：1.5 mm

规格：600*600mm

表面：镜光

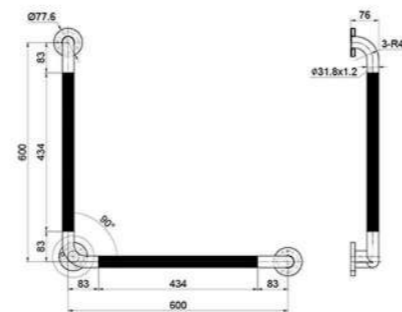

尼龙-不锈钢扶手-标准款



名称：尼龙防滑直扶手 (SG.001)
材质：SUS304+尼龙
管径： $\Phi 35$
管厚：1.0 mm、1.2 mm
规格：300mm、460mm、600mm
表面：白色

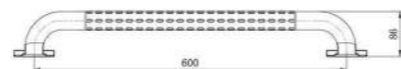

名称：尼龙防滑U型扶手 (UG.002)
材质：SUS304+尼龙
管径： $\Phi 35$
管厚：1.0 mm、1.2 mm
规格：600mm
表面：白色

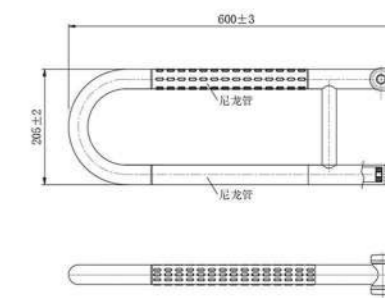

名称：尼龙防滑90°扶手 (YG.004)
材质：SUS304+尼龙
管径： $\Phi 35$
管厚：1.0 mm、1.2 mm
规格：600*600mm
表面：白色

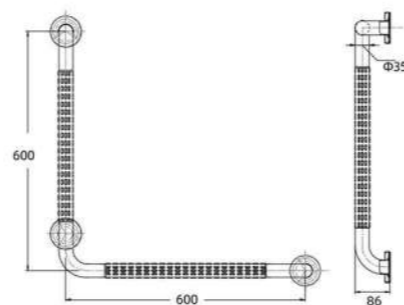

不锈钢扶手-标准款



名称：不锈钢直扶手 (SG.001)
材质：SUS304
管径： $\phi 32$
管厚：1.0 mm、1.2 mm
规格：300mm、450mm、600mm
表面：镜光、砂光

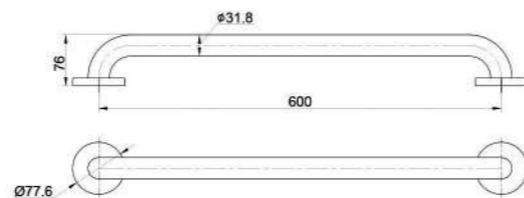

名称：不锈钢直扶手 (SG.004)
材质：SUS304
管径： $\phi 32$
管厚：1.0 mm、1.2 mm
规格：300mm、450mm、600mm
表面：镜光、砂光

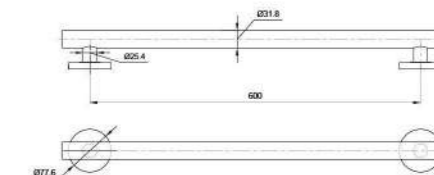

名称：不锈钢135°扶手 (YG.001)
材质：SUS304
管径： $\phi 32$
管厚：1.0 mm、1.2 mm
规格：300*300mm
表面：镜光、砂光

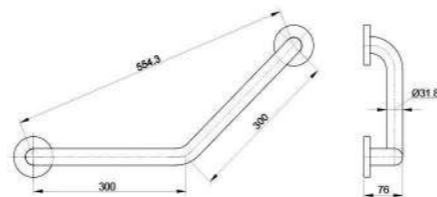

名称：不锈钢135°扶手(带香皂篮) (YG.001)
材质：SUS304
管径： $\phi 32$
管厚：1.0 mm、1.2 mm
规格：300*300mm
表面：镜光、砂光

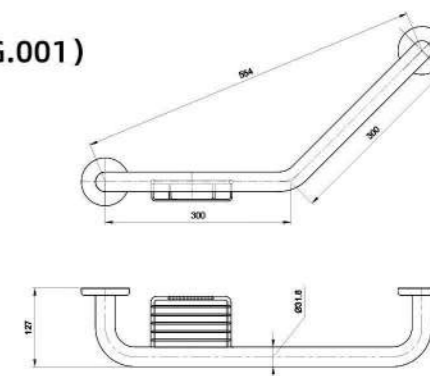

名称：不锈钢单边洗手台扶手 (YG.023)
材质：SUS304
管径： $\phi 32$
管厚：1.0 mm、1.2 mm
规格：800*750mm
表面：镜光、砂光

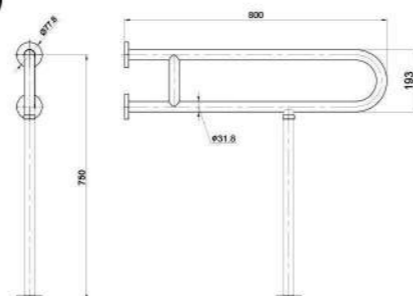

名称：不锈钢大理石扶手 (YG.010)
材质：SUS304
管径： $\phi 25$ 、 $\phi 32$
管厚：1.0 mm、1.2 mm
规格：600*160mm
表面：镜光、砂光

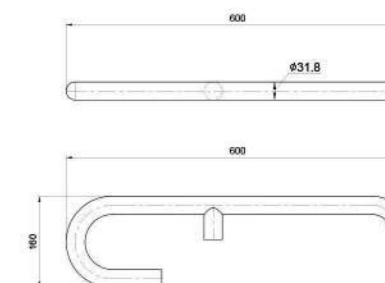

不锈钢扶手-标准款



名称：不锈钢直扶手(SG.006)

材质：SUS304

管径： $\phi 32$

管厚：1.0 mm、1.2 mm

规格：300mm、450mm、600mm

表面：镜光、砂光

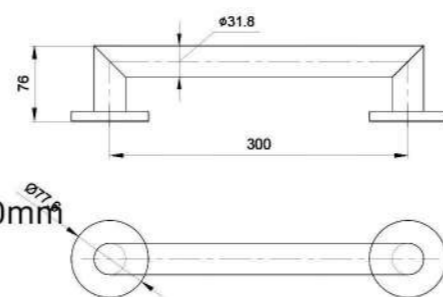

名称：不锈钢扶手(SG.002)

材质：SUS304

管径： $\phi 32$

管厚：1.0 mm、1.2 mm

规格：300mm、450mm、600mm

表面：镜光、砂光

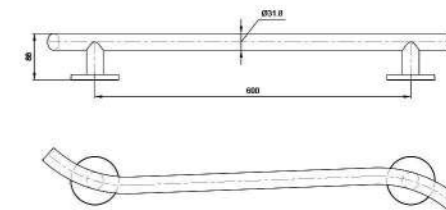

名称：不锈钢90°扶手(YG.004)

材质：SUS304

管径： $\phi 32$

管厚：1.0 mm、1.2 mm

规格：600*600mm

表面：镜光、砂光

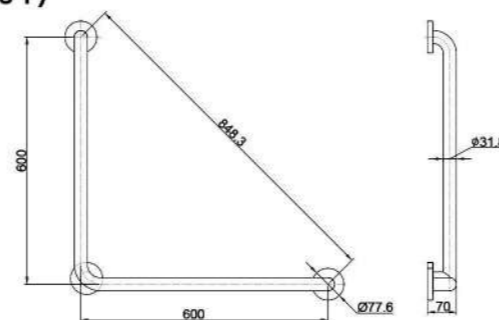

名称：不锈钢L型扶手(YG.004)

材质：SUS304

管径： $\phi 32$

管厚：1.0 mm、1.2 mm

规格：600*300mm

表面：镜光、砂光

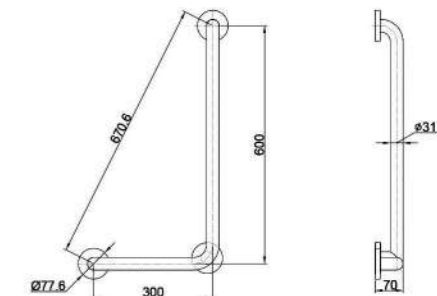

名称：不锈钢上翻扶手(UG.002)

材质：SUS304

管径： $\phi 32$

管厚：1.0 mm、1.2 mm

规格：600mm

表面：镜光、砂光

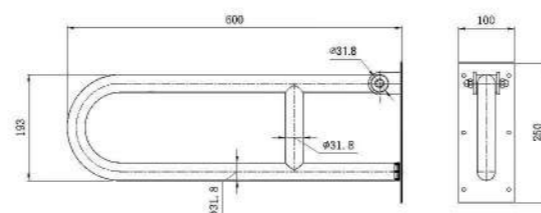

名称：不锈钢上翻扶手(带挂钩)(UG.002)

材质：SUS304

管径： $\phi 32$

管厚：1.0 mm、1.2 mm

规格：600mm

表面：镜光、砂光

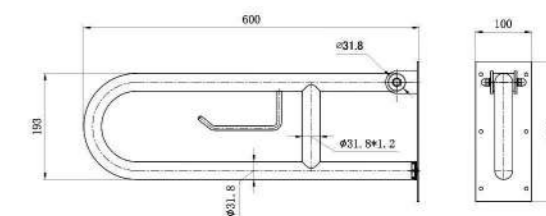

不锈钢扶手-标准款



名称：不锈钢小便器扶手 (YG.027)

材质：SUS304

管径： $\phi 32$

管厚：1.0 mm、1.2 mm

规格：600*550*490mm

表面：镜光、砂光

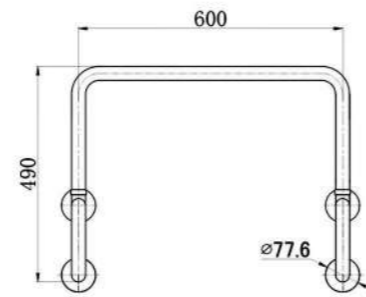

名称：不锈钢洗手台扶手 (YG.024)

材质：SUS304

管径： $\phi 32$

管厚：1.0 mm、1.2 mm

规格：800*650*780mm

表面：镜光、砂光

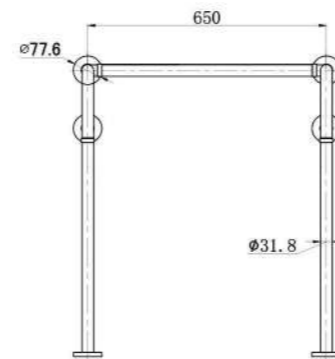

名称：不锈钢洗手台双支撑扶手 (YG.026)

材质：SUS304

管径： $\phi 32$

管厚：1.0 mm、1.2 mm

规格：600C*445.9mm

表面：镜光、砂光

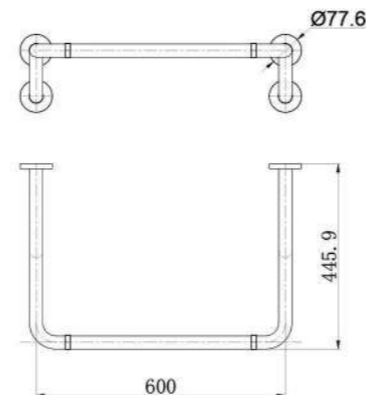

名称：不锈钢H型马桶扶手 (YG.014)

材质：SUS304

管径： $\phi 25$ 、 $\phi 32$

管厚：1.0 mm、1.2 mm

规格：600*160mm

表面：镜光、砂光

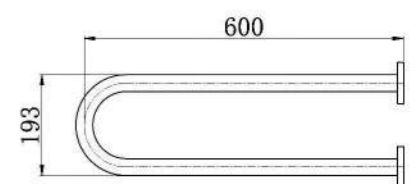

名称：不锈钢H型马桶扶手 (YG.011)

材质：SUS304

管径： $\phi 32$

管厚：1.0 mm、1.2 mm

规格：838*150*762mm

表面：镜光、砂光

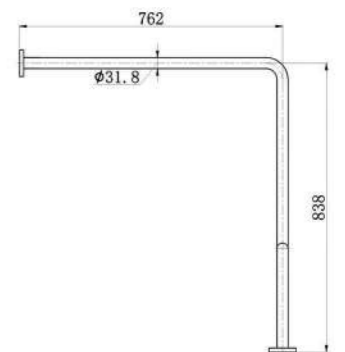

名称：不锈钢淋浴扶手 (YG.019)

材质：SUS304

管径： $\phi 32$

管厚：1.0 mm、1.2 mm

规格：600*1100mm

表面：镜光、砂光

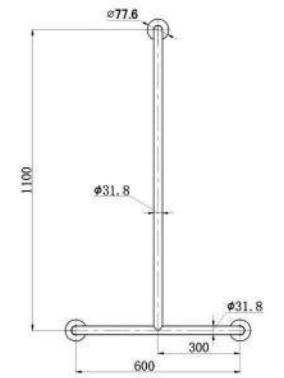

不锈钢扶手-出口认证款



名称：不锈钢转角扶手(YG.017)

材质：SUS304

管径： $\phi 32$

管厚：1.0 mm、1.2 mm

规格：600*900mm

表面：镜光、砂光

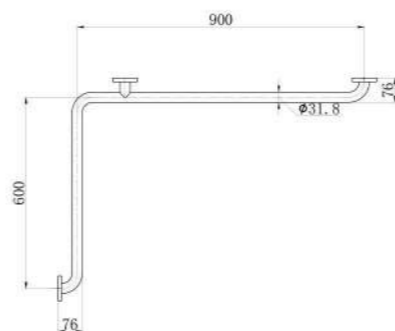

名称：不锈钢转角扶手(YG.008)

材质：SUS304

管径： $\phi 32$

管厚：1.0 mm、1.2 mm

规格：300mm*600mm

表面：镜光、砂光

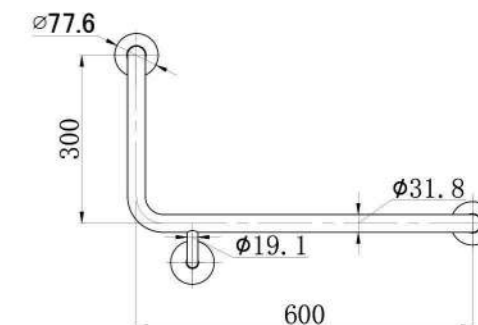

名称：不锈钢转角扶手(YG.007)

材质：SUS304

管径： $\phi 32$

管厚：1.0 mm、1.2 mm

规格：450*600mm

表面：镜光、砂光

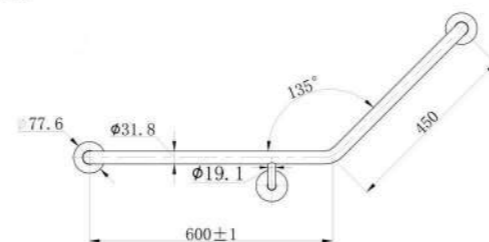

名称：不锈钢转角扶手(YG.020-1)

材质：SUS304

管径： $\phi 32$

管厚：1.0 mm、1.2 mm

规格：600*600*300mm

表面：镜光、砂光

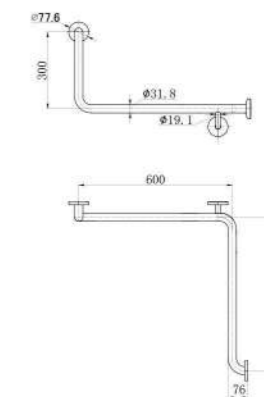

名称：不锈钢转角扶手(YG.020)

材质：SUS304

管径： $\phi 32$

管厚：1.0 mm、1.2 mm

规格：600*450*600mm

表面：镜光、砂光

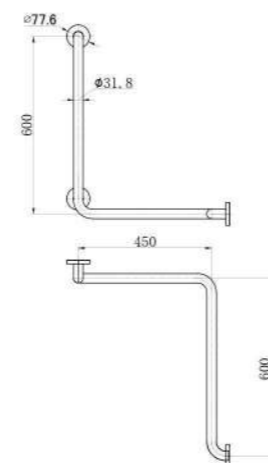

名称：不锈钢转角扶手(YG.021)

材质：SUS304

管径： $\phi 32$

管厚：1.0 mm、1.2 mm

规格：900*600*300mm

表面：镜光、砂光

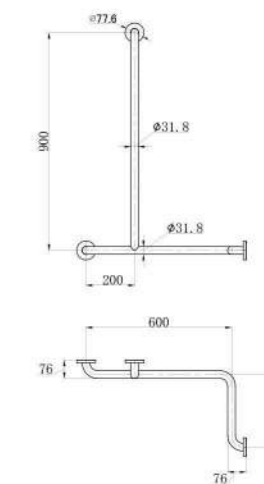

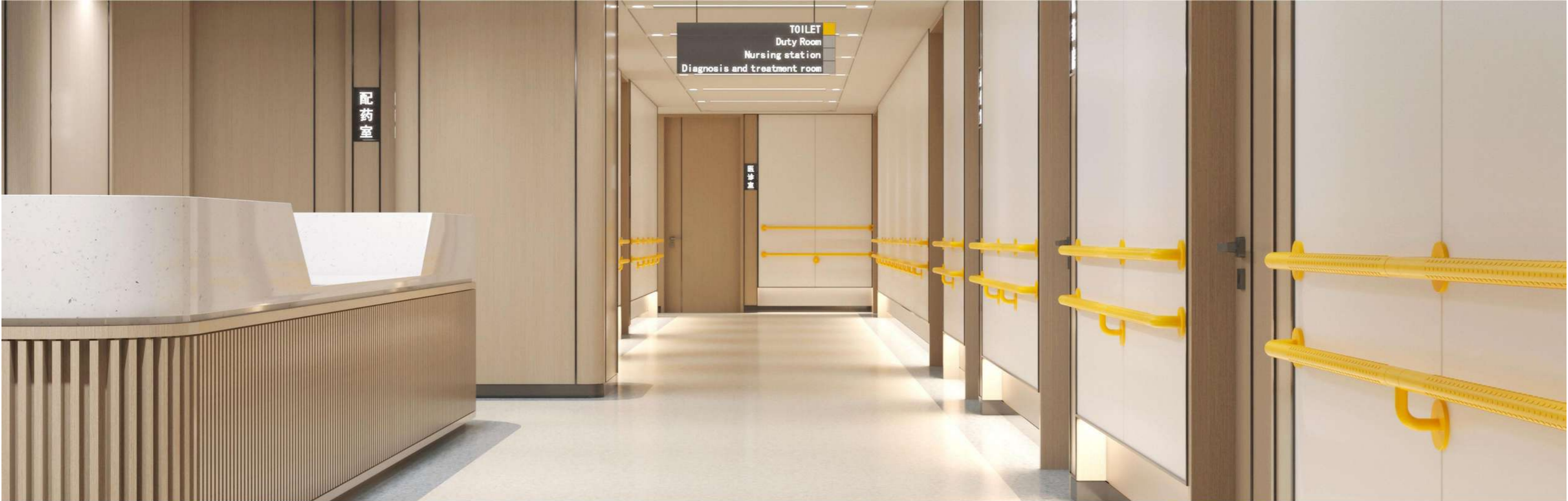

医养通道扶手-标准款

名称：直脚支撑连接件

材质：SUS304

管径： $\phi 32$

管厚：1.0 mm

规格：600*600mm

表面：黄色、白色



名称：阳直转角配件

材质：SUS304

管径： $\phi 32$

管厚：1.0 mm

规格：260mm

表面：黄色、白色



名称：两端收口件(缩口)

材质：SUS304

管径： $\phi 32$

管厚：1.0 mm

规格：160mm

表面：黄色、白色



名称：阴直转角配件

材质：SUS304

管径： $\phi 32$

管厚：1.0 mm

规格：260mm

表面：黄色、白色



名称：弯脚支撑连接件

材质：SUS304

管径： $\phi 32$

管厚：1.0 mm

规格：200mm

表面：黄色、白色



名称：阳弯转角配件

材质：SUS304

管径： $\phi 32$

管厚：1.0 mm

规格：260mm

表面：黄色、白色



名称：弯活动转角配件

材质：SUS304

管径： $\phi 32$

管厚：1.0 mm

规格：1340mm

表面：黄色、白色



名称：阴直转角配件

材质：SUS304

管径： $\phi 32$

管厚：1.0 mm

规格：260mm

表面：黄色、白色



康养二合一挂件扶手-标准款



名称：二合一扶手
材质：SUS304
管径： $\phi 32$
管厚：1.2 mm
规格：610mm
表面：镜光

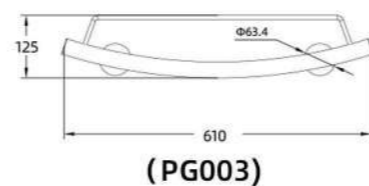

名称：二合一扶手
材质：SUS304
管径： $\phi 32$
管厚：1.2 mm
规格：314C*273.5C*90H
表面：镜光

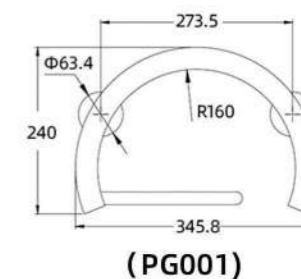

名称：二合一扶手
材质：SUS304
管径： $\phi 32$
管厚：1.2 mm
规格：457*108*133mm
表面：镜光

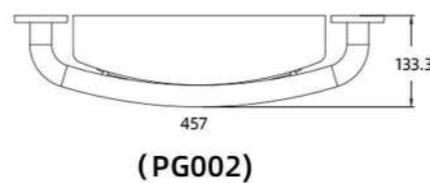

名称：二合一扶手
材质：SUS304
管径： $\phi 32$
管厚：1.2 mm
规格：314C*273.5C*70H*149
表面：镜光

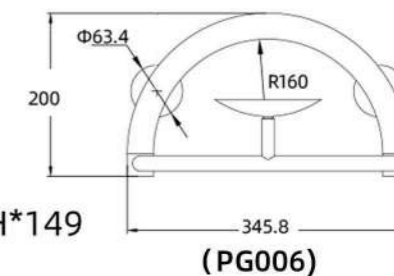

康养二合一挂件扶手-标准款

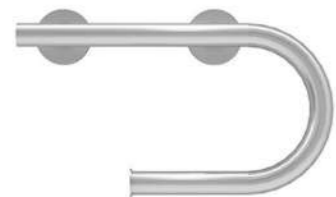

名称：二合一扶手
 材质：SUS304
 管径：Φ32
 管厚：1.2 mm
 规格：419L*232W*210C
 表面：镜光

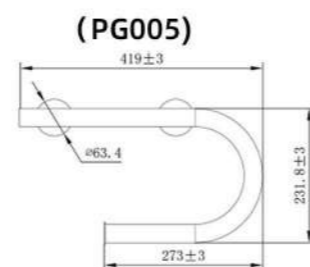

名称：二合一扶手
 材质：SUS304
 管径：Φ32
 管厚：1.2 mm
 规格：314C*273.5C*90H
 表面：镜光

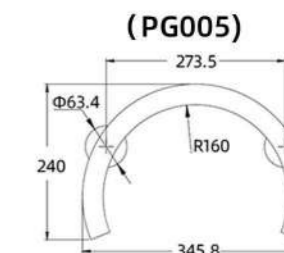

名称：二合一扶手
 材质：SUS304
 管径：Φ32
 管厚：1.2 mm
 规格：719L*500W*550C
 表面：镜光



名称：二合一扶手
 材质：SUS304
 管径：Φ32
 管厚：1.2 mm
 规格：719L*500W*550C
 表面：镜光

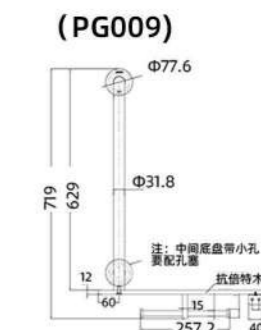

浴室凳-标准款



名称：浴室凳 SE01-01

材质：SUS304

管径：φ32

管厚：1.2 mm

规格：450*400mm

表面：镜光、砂光

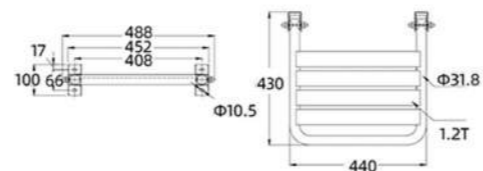

名称：浴室凳

材质：SUS304+软垫

管径：φ25.4

管厚：1.2 mm

规格：550*400mm

表面：镜光、砂光

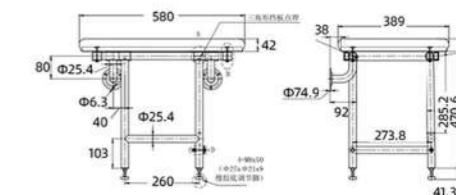

名称：浴室凳SE02-01B

材质：SUS304+软垫

管径：φ32

管厚：1.2 mm

规格：450*400mm

表面：镜光、砂光

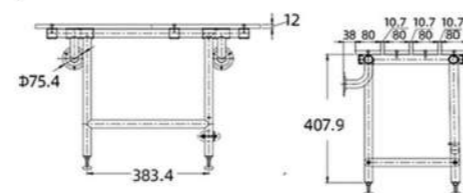

名称：浴室凳

材质：SUS304+抗倍特板

管径：φ25.4

管厚：1.2 mm

规格：710*350mm

表面：镜光、砂光

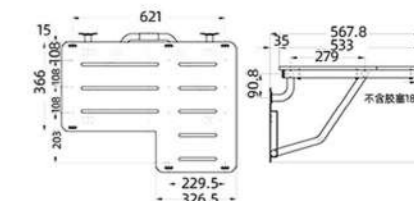

名称：浴室凳SE03-01

材质：SUS304+软垫

管径：φ25*25

管厚：1.2 mm

规格：355*280mm

表面：镜光、砂光

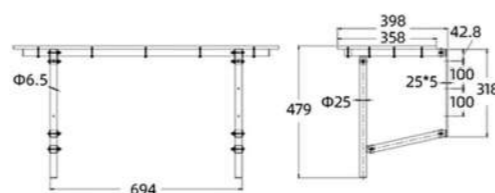

名称：浴室凳

材质：SUS304+抗倍特板

管径：φ25.4

管厚：1.2 mm

规格：550*400mm

表面：镜光、砂光

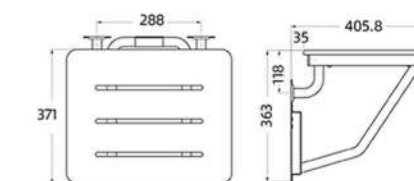

浴室凳-柚木款



名称：实木浴室凳
材质：SUS304+实木
管径：φ51
管厚：1.2 mm
规格：450*400mm
表面：镜光、砂光、半光黑色



名称：柚木折叠浴室凳（带支脚）
材质：SUS304+实木
管径：φ51
管厚：1.2 mm
规格：567*399*435mm
表面：镜光、砂光、半光黑色



名称：柚木折叠浴室凳（带扶手）
材质：SUS304+实木
管径：φ51
管厚：1.2 mm
规格：567*399*405mm
表面：镜光、砂光、半光黑色



名称：折叠式实木浴室凳
材质：SUS304+实木+POM
管径：φ38
管厚：1.0mm
规格：408 * 340 * 48MM
表面：镜光、砂光、半光黑色

靠背-标准款



名称：马桶靠背
材质：SUS304+PU垫
管径： $\phi 32$
管厚：1.2 mm
规格：365*150*40mm
表面：镜光、砂光、白色

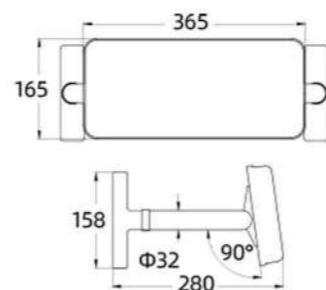

名称：马桶靠背
材质：SUS304+PU垫
管径： $\phi 32$
管厚：1.2 mm
规格：365*160*40mm
表面：镜光、砂光、白色

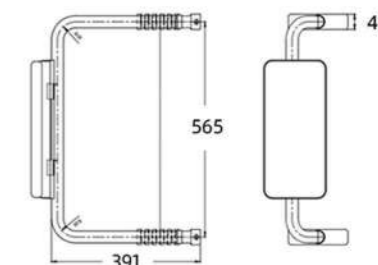

名称：马桶靠背
材质：SUS304+PU垫
管径： $\phi 32$
管厚：1.2 mm
规格：365*160*40mm
表面：镜光、砂光、白色

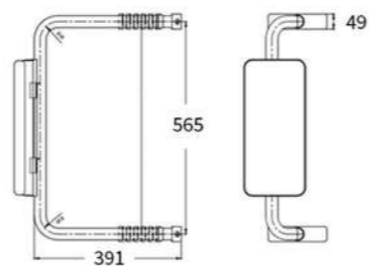

名称：马桶靠背
材质：SUS304+PU垫
管径： $\phi 32$
管厚：1.2 mm
规格：365*150*40mm
表面：镜光、砂光、白色

康养卫浴镜/智能集成镜柜



名称：平镜
材质：不锈钢304
规格：500*700 / 600*900mm
板厚：0.7mm
表面：砂光、镜光、白色
玻璃：厚度6mm，镀银/防雾
安装：打孔挂墙



名称：无障碍专用镜
材质：不锈钢304
规格：500*700*25/95mm
600*900*25/95mm
板厚：0.7mm
表面：砂光、镜光、白色
玻璃：厚度6mm，镀银/防雾
安装：打孔挂墙



名称：角度可调无障碍镜
材质：不锈钢304
规格：500*700*25/95mm
600*900*25/95mm
板厚：0.7mm
表面：砂光、镜光、白色
玻璃：厚度6mm，镀银/防雾
安装：打孔挂墙



名称：智能集成镜柜
材质：不锈钢304
规格：900*900/146mm
板厚：0.7mm
表面：砂光
玻璃：厚度5mm，镀银/防雾
安装：打孔挂墙