



GUANGDONG ROSERY BATH SCIENCE AND TECHNOLOGY CO., LTD.

www.roserybath.com Tel: +86-760-88407903 Fax:+86-760-88407903

SHOWER DOOR



ABOUT ROSEY

Founded in the 1990s, Rosery is a national high-tech enterprise specializing in custom bathroom solutions, including shower enclosures, bathroom vanities, smart toilets, and shower systems, as well as custom home products such as partition doors, eco doors, and glass-metal cabinets. Rosery has established a fully integrated intelligent manufacturing base covering nearly 200,000 square meters in Taishan, China, equipped with advanced production lines for glass processing, aluminum profiles, hardware components, and finished bathroom products. This vertically integrated manufacturing system enables us to ensure consistent quality, efficient production, and continuous innovation.

Our quality management system is certified to ISO 9001, ISO 14001, and ISO 45001, demonstrating our commitment to quality, environmental responsibility, and workplace safety.

Today, Rosery's business operates through three major channels: international export, domestic retail, and project business. Our products are exported to more than 30 countries and regions, including the United States, Canada, the United Kingdom, France, and Australia. In China, Rosery has built an extensive retail network with nearly 1,000 stores across more than 600 cities and has established strategic partnerships with leading real estate developers and national home furnishing chains.

With decades of industry experience, Rosery continues to pursue innovation in design, technology, and manufacturing, delivering reliable, elegant, and high-quality bathroom solutions for customers worldwide.

Together with our customers, we embrace the future and pursue our shared vision.

Taishan Intelligent Manufacturing Base

Covers an area of **240,000m²**



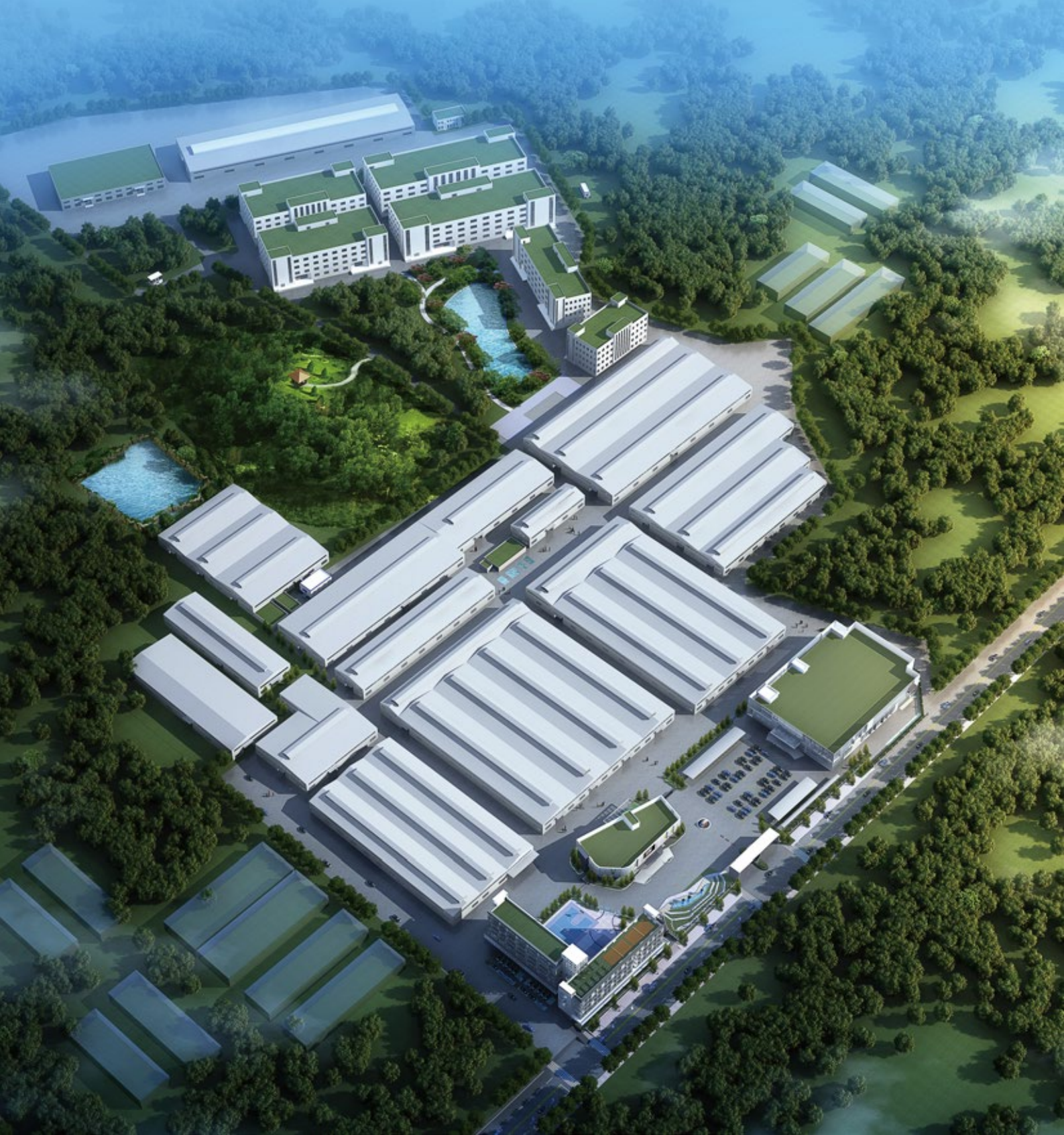

Shower door production line

SMART MANUFACTURING



MAIN MATERIAL PROCESSING



Stable Material Supply

We are the pioneer to make aluminium, glass and hardware by ourselves in the industry.

INTELLIGENT SHOWER DOOR PRODUCTION LINE



High Production Efficiency

Robotic arms in production line, precise and efficient.

INTERTEK CERTIFIED LABORATORY



Professional R&D Team

All the engineers have more than 5 years of shower door industry experience.

WELCOME TO

TAISHAN PRODUCTION BASE

QUALIFICATIONS



ISO9001 International Quality System Certification



ISO14001 International Environmental System Certification



ISO45001 International Occupational Health and Safety Management System Certification



CUPC Certificate



CE Certificate



FSC Certificate

The 3rd Testing Party Intertek has assessed Rosery laboratory and confirmed it complies with EN14428:2015 standard.

Rosery is the first shower enclosure company to be approved as an Intertek Satellite laboratory in China.

HONORS



GERMANY RED DOT AWARD



GERMANY RED DOT AWARD



GERMANY IF DESIGN AWARD



GERMANY IF DESIGN AWARD



MUSE DESIGN AWARDS



MUSE DESIGN AWARDS



Kapok China Design Award



A'DESIGN AWARD

CONTENTS

05	BQ Series	FAST INSTALLATION	Aluminium frame	111	FZ Series	NEW	Stainless steel frame
17	DF Series	FAST INSTALLATION	NEW Aluminium frame	113	DH Series		Aluminium frame
31	EI Series	FAST INSTALLATION	NEW Aluminium frame	115	ES Series	NEW	Aluminium frame
39	FJ Series	NEW	Stainless steel frame	117	DE Series		Aluminium frame
45	FN Series	NEW	Stainless steel frame	119	DC Series		Aluminium frame or Stainless steel frame
59	AEN+FL Series		Aluminium frame	121	PB Series		Aluminium frame
69	AY Series	FAST INSTALLATION	Aluminium frame	123	CV Series		Aluminium frame
79	EH Series		Aluminium frame	125	FS Series	NEW	Aluminium frame
81	EG Series		Aluminium frame	127	FH Series	NEW	Aluminium frame
85	FM Series	FAST INSTALLATION	NEW Aluminium frame	131	PP Series	NEW	Stainless steel frame
89	PH Series	FAST INSTALLATION	Aluminium frame	137	GB Series	NEW	Stainless steel frame
93	FR Series	FAST INSTALLATION	NEW Aluminium frame or Stainless steel frame	139	DV Series		Stainless steel frame
97	CG Series	FAST INSTALLATION	Aluminium frame	145	CI Series		SUS304 Top bar, Aluminium wall profile
101	DU Series	NEW	Aluminium frame	153	VX Series		Aluminium frame
105	EY Series	NEW	Aluminium frame	157	FT Series	NEW	Stainless steel frame
109	PF Series		Aluminium frame	163	BY Series		Stainless steel frame
				179	WALK IN Series		Aluminium frame

Glass color

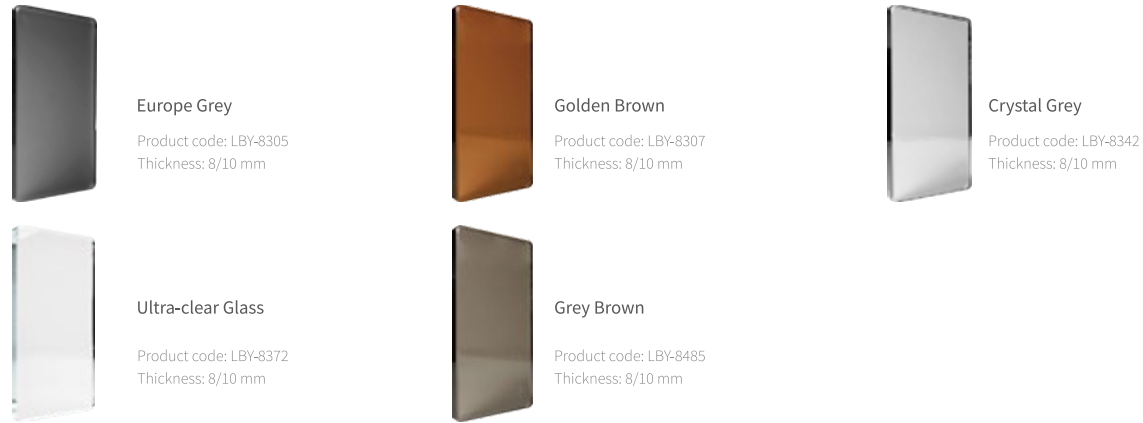

Laminated glass (Applicable to full frame shower room only)

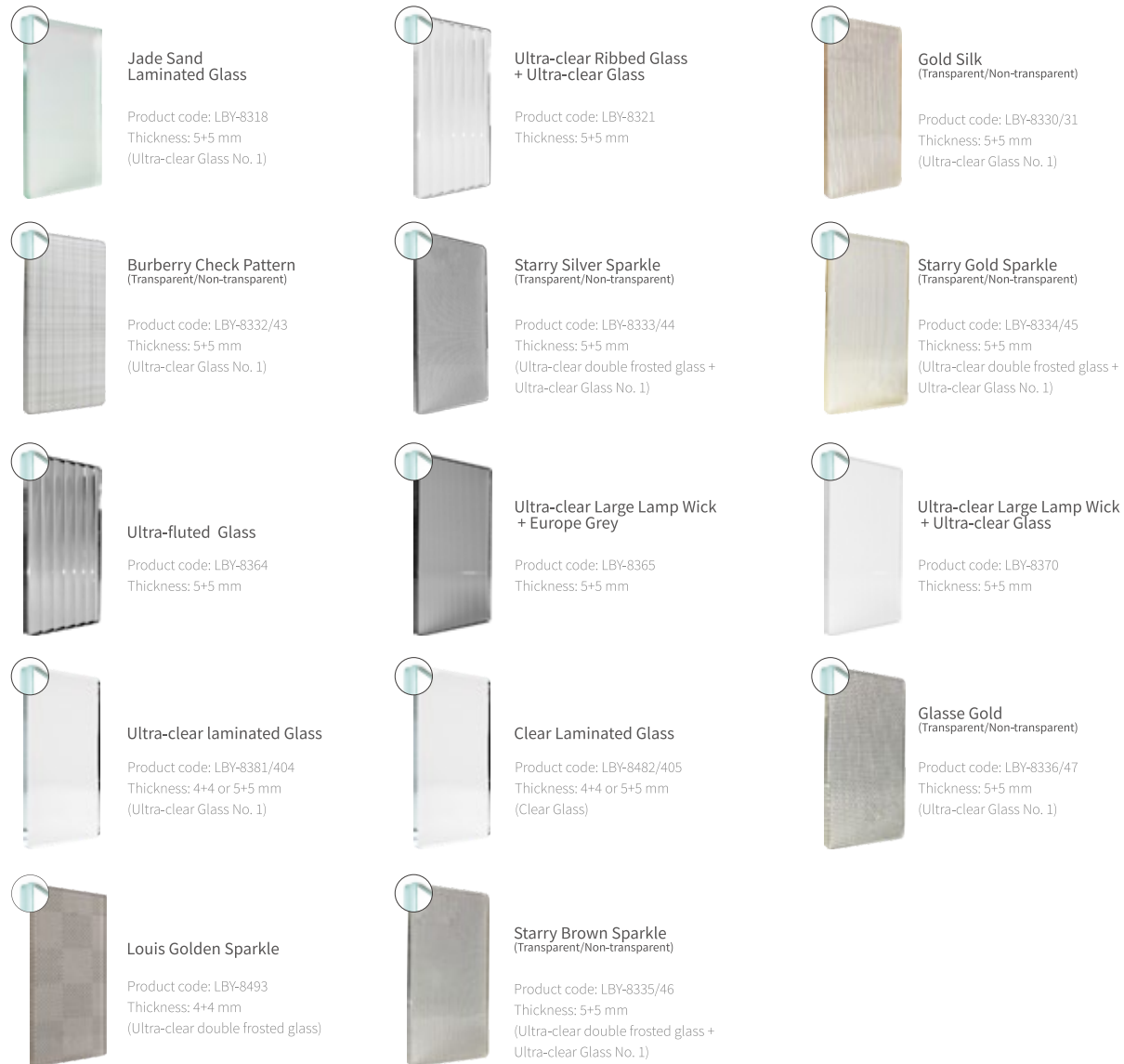

Cragglass



Patterned glass

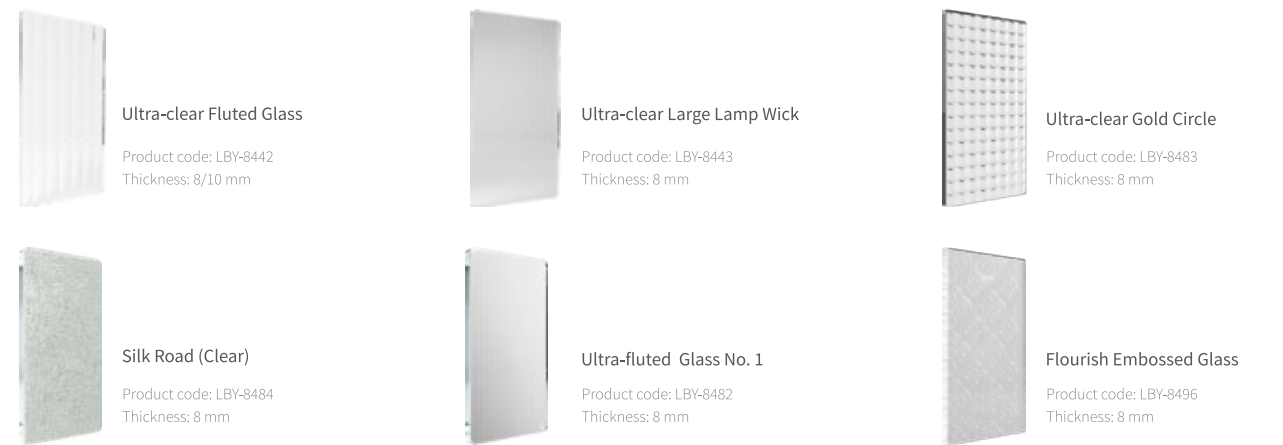

Colored laminated glass (Applicable to full frame shower room only)

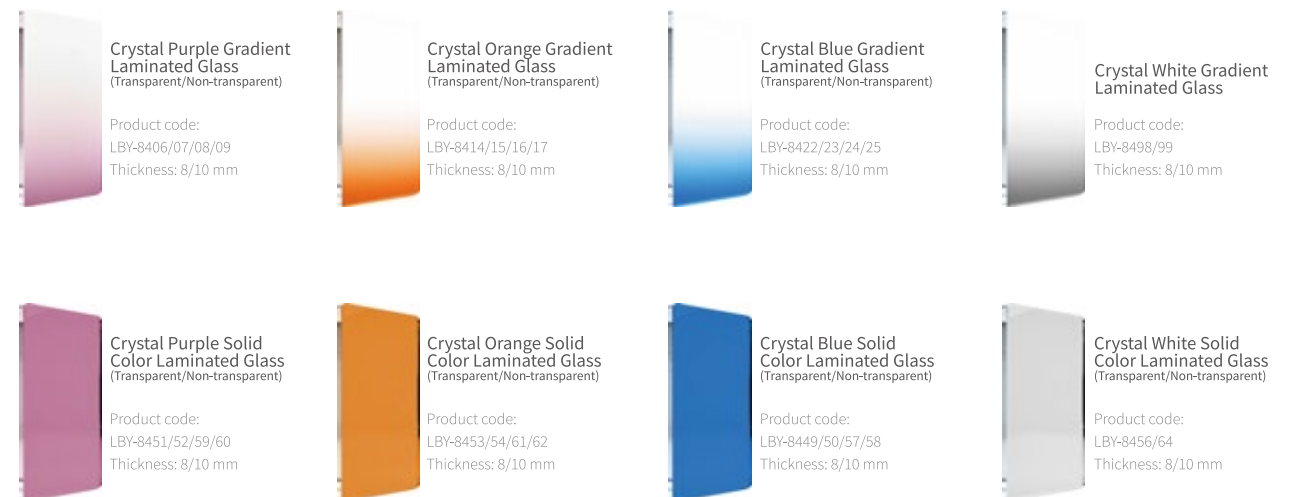

Shower door handles

Shower door handles

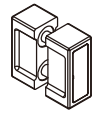

Product code: LS-8152
Size: 45 x 20
Material: Zinc

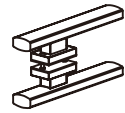

Product code: LS-8073
Size : Hole distance 57
Material: Stainless steel

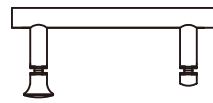

Product code: LS-8015
Size: Ø19(Hole distance 144)
Material: Stainless steel

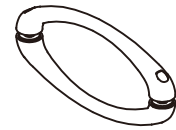

Product code: LS-8121
Size: Hole distance 144
Material: ABS

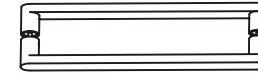

Product code: LS-8112
Size: 25x13(Hole distance 300)
Material: Stainless steel

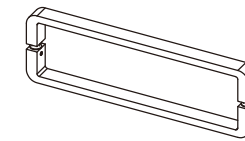

Product code: LS-8070
Size: 11x22(Hole distance 300)
Material: Zinc

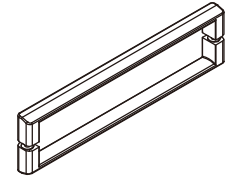

Product code: LS-8110
Size: 300/320
Material: Stainless steel

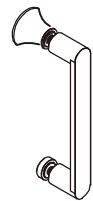

Product code: LS-8211
Size: Hole distance 145
Material: Zinc

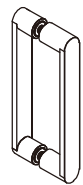

Product code: LS-8210
Size: Hole distance 145
Material: Zinc

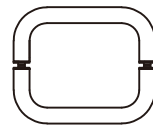

Product code: LS-8069
Size: Ø19(Hole distance 150)
Material: Stainless steel

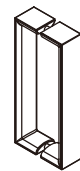

Product code: LS-8151
Size: 170
Material: Zinc



Product code: LS-8063
Size: Hole distance 380
Material: Zinc

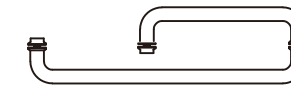

Product code: LS-8005
Size: 300* (400/500)
Material: Stainless steel

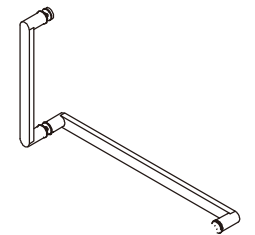

Product code: LS-8157
Size: 450/250
Material: SUS304

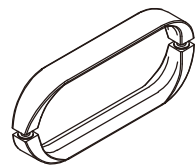

Product code: LS-8164
Size: Hole distance 200
Material: Zinc

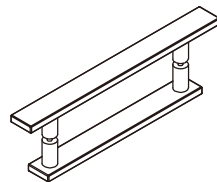

Product code: LS-8129
Size: 225/300
Material: SUS304

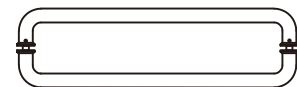

Product code: LS-8001
Size: Ø25(Hole distance 275/375/475)
Material: Stainless steel

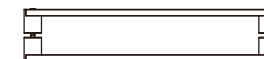

Product code: LS-8047
Size: Hole distance 475 (Can be customized)
Material: Zinc + Aluminum

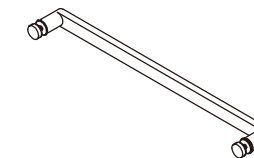

Product code: LS-8111
Size: Hole distance 400/500
Material: SUS304

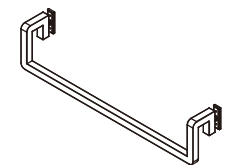

Product code: LS-8217
Size: Hole distance 450/550/650
Material: SUS304

**FAST
INSTALLATION**



PATENT CERTIFICATE NUMBER



ZL202021895109.3
ZL202020004479.7

FRAME MATERIAL: Aluminum

FRAME COLORS



Quick connection details between wall profile and guide rail



Separate quick-installation details of the roller



Guide rail cross-section details



Bumper block details



GLASS THICKNESS



HEIGHT 2000MM



PRODUCT ADJUSTMENT



REVERSIBLE FOR LEFT OR RIGHT



ALL SCREWS ARE HIDDEN



FAST INSTALLATION

*Other handles are available. For more information, please see page 13.



BQ-S721

Width B	Product code	Adjustment min-max B	Door opening C
1000	BQ-S721-A	954-990	364
1100	BQ-S721-B	1054-1090	414
1200	BQ-S721-C	1154-1190	464
1400	BQ-S721-D	1354-1390	564
1500	BQ-S721-E	1454-1490	564
1600	BQ-S721-F	1554-1590	564
1700	BQ-S721-G	1654-1690	564

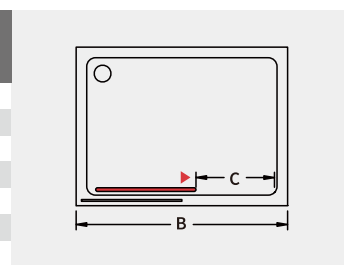

BQ-SP

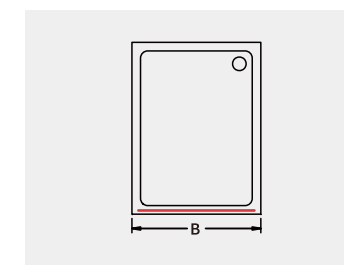

Width B	Product code	Adjustment min-max B
700	BQ-SP-A	670-690
760	BQ-SP-B	730-750
800	BQ-SP-C	770-790
900	BQ-SP-D	870-890
1000	BQ-SP-E	970-990



FRAME MATERIAL: Aluminum



Glass clamp details

PATENT CERTIFICATE NUMBER

 ZL202021895109.3
ZL202020004479.7

- 
GLASS THICKNESS
- 
HEIGHT 2000MM
- 
PRODUCT ADJUSTMENT
- 
REVERSIBLE FOR LEFT OR RIGHT
- 
ALL SCREWS ARE HIDDEN
- 
FAST INSTALLATION

*Other handles are available. For more information, please see page 13.



BQ-P711

Width B	Product code	Adjustment min-max B	Door opening C
760	BQ-P711-A	710-750	502
800	BQ-P711-B	750-790	542
900	BQ-P711-C	850-890	642
1000	BQ-P711-D	950-990	712

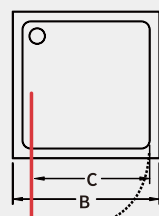

BQ-B722

Width B	Product code	Adjustment min-max B	Door opening C
760	BQ-B722-A	710-750	423
800	BQ-B722-B	750-790	463
900	BQ-B722-C	850-890	563
1000	BQ-B722-D	950-990	663

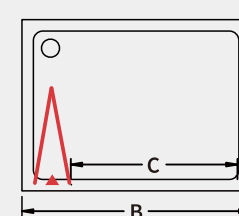



FRAME MATERIAL: Aluminum



PATENT CERTIFICATE NUMBER

 ZL202021895109.3
ZL202020004479.7

S142 corner connection details

BQ-S142

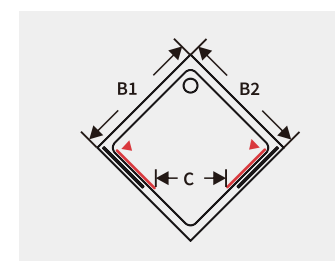

Width B1/B2	Product code	Adjustment min-max B1/B2	Door opening C
760 / 760	BQ-S142-A	732-750 / 732-750	376
800 / 800	BQ-S142-B	772-790 / 772-790	404
900 / 900	BQ-S142-C	872-890 / 872-890	474



BQ-S431

Width B1/B2	Product code	Adjustment min-max B	Door opening C
760 / 900	BQ-S431-A	732-750 / 872-890	418
800 / 1000	BQ-S431-B	772-790 / 972-990	418
900 / 1200	BQ-S431-C	872-890 / 1172-1190	465

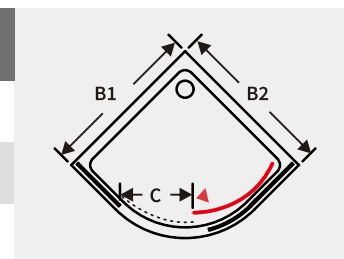

BQ-S442

Width B1/B2	Product code	Adjustment min-max B	Door opening C
800 / 800	BQ-S442-A	772-790 / 772-790	372
900 / 900	BQ-S442-B	872-890 / 872-890	515
1000 / 1000	BQ-S442-C	972-990 / 972-990	515

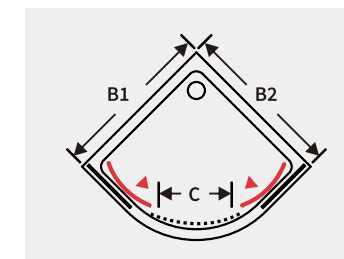



FRAME MATERIAL: Aluminium frame

FRAME COLORS

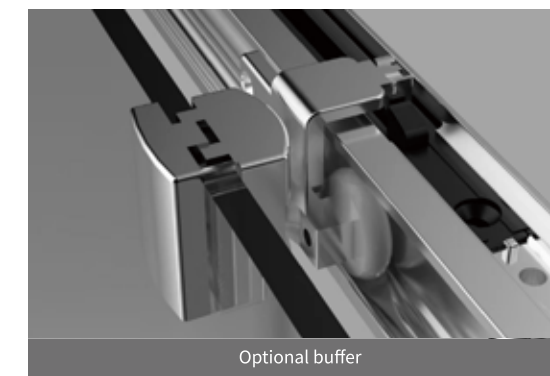

DF-S721

Width B	Product code	Adjustment min-max B	Door opening C
1000	S721-A	960-1000	370
1100	S721-B	1060-1100	420
1200	S721-C	1160-1200	470
1400	S721-D	1360-1400	570
1500	S721-E	1460-1500	570
1600	S721-F	1560-1600	570
1700	S721-G	1660-1700	570

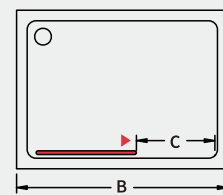

- 
6
mm
 GLASS THICKNESS
- 
 HEIGHT
 2000MM
- 
20
mm
 PRODUCT ADJUSTMENT
- 
 REVERSIBLE FOR LEFT OR RIGHT
- 
 ALL SCREWS ARE HIDDEN
- 
 FAST INSTALLATION

*Other handles are available. For more information, please see page 13.



DF-SP

Width B	Product code	Adjustment min-max B	Door opening C
700	SP-A	680-700	/
760	SP-B	740-760	
800	SP-C	780-800	
900	SP-D	880-900	
1000	SP-E	980-1000	

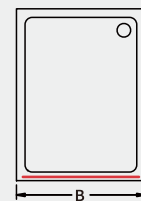

DF-S142

Width B1/B2	Product code	Adjustment min-max B	Door opening C
800/800	S142-A	780-800	420
900/900	S142-B	880-900	490
1000/1000	S142-C	980-1000	560

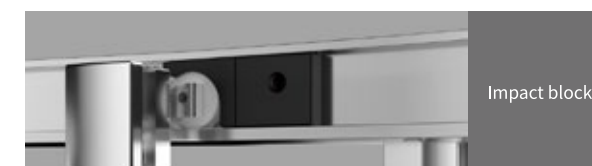
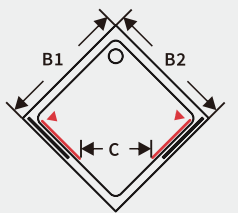

Impact block



DF-S431

Width B1/B2	Product code	Adjustment min-max B	Door opening C
760/900	S431-A	740-760/880-900	400
800/800	S431-B	780-800	415
900/900	S431-C	880-900	470
1000/1000	S431-D	980-1000	470
800/1000	S431-E	780-800/980-1000	415
800/1200	S431-F	780-800/1180-1200	415
900/1200	S431-G	880-900/1180-1200	470

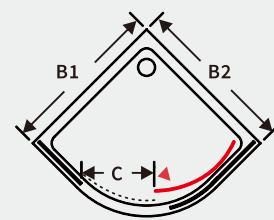

DF-S442

Width B1/B2	Product code	Adjustment min-max B	Door opening C
800/800	S442-A	780-800	425
900/900	S442-B	880-900	545
1000/1000	S442-C	980-1000	545

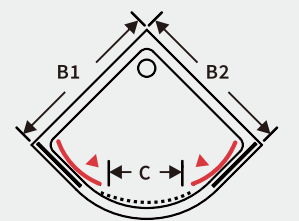



DF-P711A

Width B	Product code	Adjustment min-max B	Door opening C
760	P711A-A	730-760	485
800	P711A-B	770-800	525
900	P711A-C	870-900	625
1000	P711A-D	970-1000	725

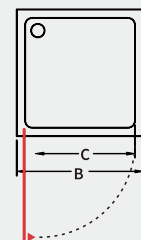

DF-SP

Width B	Product code	Adjustment min-max B	Door opening C
700	SP-A	680-700	/
760	SP-B	740-760	
800	SP-C	780-800	
900	SP-D	880-900	
1000	SP-E	980-1000	

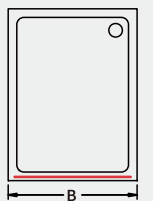



DF-B711

Width B	Product code	Adjustment min-max B	Door opening C
760	B711-A	730-760	580
800	B711-B	770-800	620
900	B711-C	870-900	720
1000	B711-D	970-1000	820



Inward folding door rotation fitting

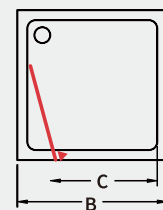

DF-SP

Width B	Product code	Adjustment min-max B	Door opening C
700	SP-A	680-700	/
760	SP-B	740-760	
800	SP-C	780-800	
900	SP-D	880-900	
1000	SP-E	980-1000	

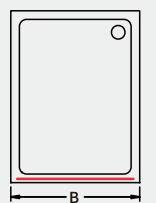



DF-P711B

Width B	Product code	Adjustment min-max B	Door opening C
760	P711B-A	730-760	485
800	P711B-B	770-800	525
900	P711B-C	870-900	625
1000	P711B-D	970-1000	725

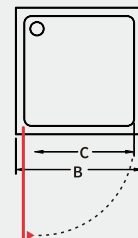

DF-SP

Width B	Product code	Adjustment min-max B	Door opening C
700	SP-A	680-700	/
760	SP-B	740-760	
800	SP-C	780-800	
900	SP-D	880-900	
1000	SP-E	980-1000	

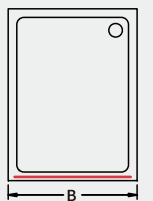



DF-B722

Width B	Product code	Adjustment min-max B	Door opening C
760	B722-A	730-760	525
800	B722-B	770-800	565
900	B722-C	870-900	665
1000	B722-D	970-1000	765

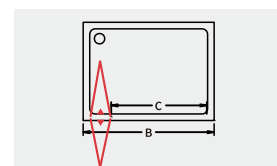

DF-SP

Width B	Product code	Adjustment min-max B	Door opening C
700	SP-A	680-700	/
760	SP-B	740-760	
800	SP-C	780-800	
900	SP-D	880-900	
1000	SP-E	980-1000	

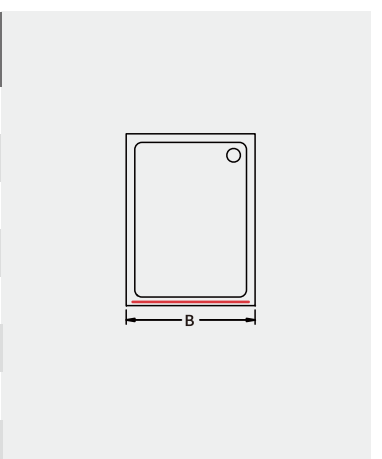



FRAME MATERIAL: Aluminium frame

FRAME COLORS

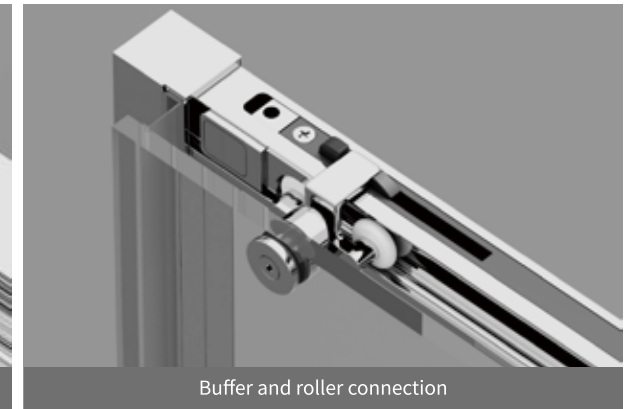
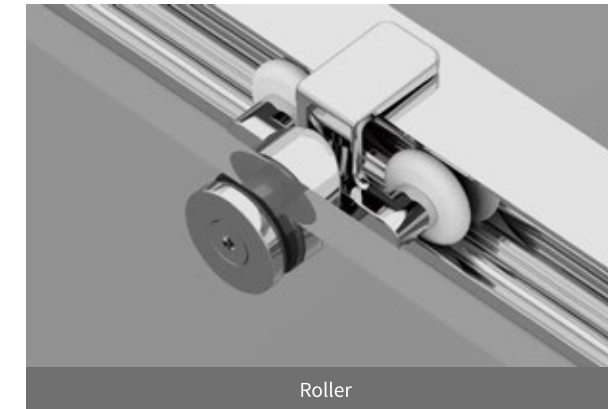

- 

8
mm
GLASS
THICKNESS
- 

HEIGHT
2000MM
- 

10
mm
PRODUCT
ADJUSTMENT
- 

REVERSIBLE FOR
LEFT OR RIGHT
- 

ALL SCREWS
ARE HIDDEN
- 

FAST
INSTALLATION

*Other handles are available. For more information, please see page 13.



EI-S721

Width B	Product code	Adjustment min-max B	Door opening C
1000	S721-A	980-1000	375
1100	S721-B	1080-1100	425
1200	S721-C	1180-1200	475
1400	S721-D	1380-1400	575
1500	S721-E	1480-1500	575
1600	S721-F	1580-1600	575
1700	S721-G	1680-1700	575

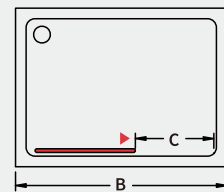

EI-SP

Width B	Product code	Adjustment min-max B	Door opening C
700	SP-A	680-690	
760	SP-B	740-750	
800	SP-C	780-790	
900	SP-D	980-990	

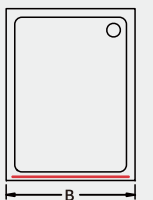



EI-S142

Width B1/B2	Product code	Adjustment min-max B	Door opening C
800/800	S142-A	780-790	387
900/900	S142-B	880-890	457
1000/1000	S142-C	980-990	457

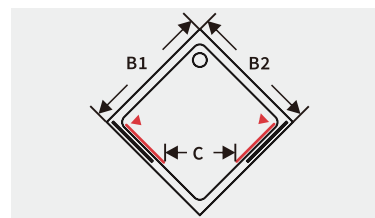

EI-S431

Width B1/B2	Product code	Adjustment min-max B	Door opening C
800/800	S431-A	780-790	388
900/900	S431-B	880-890	438
1000/1000	S431-C	980-990	438

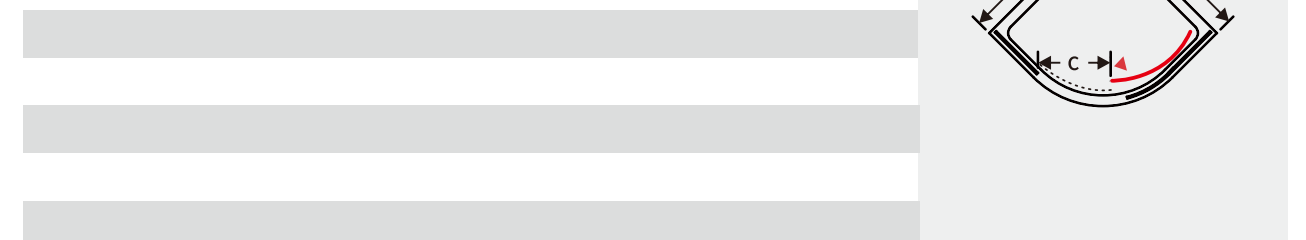
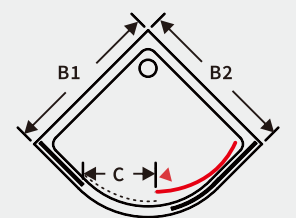

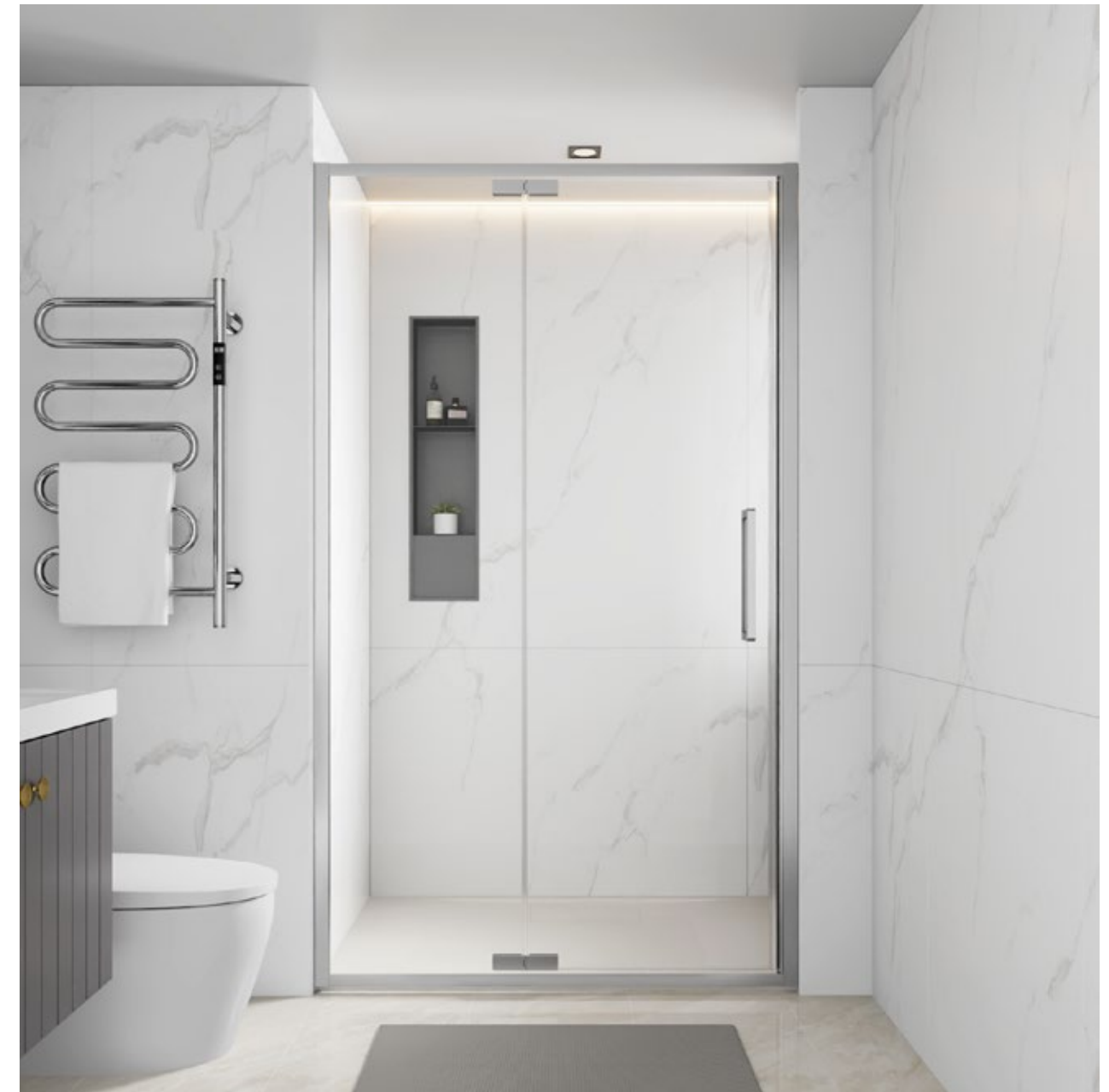
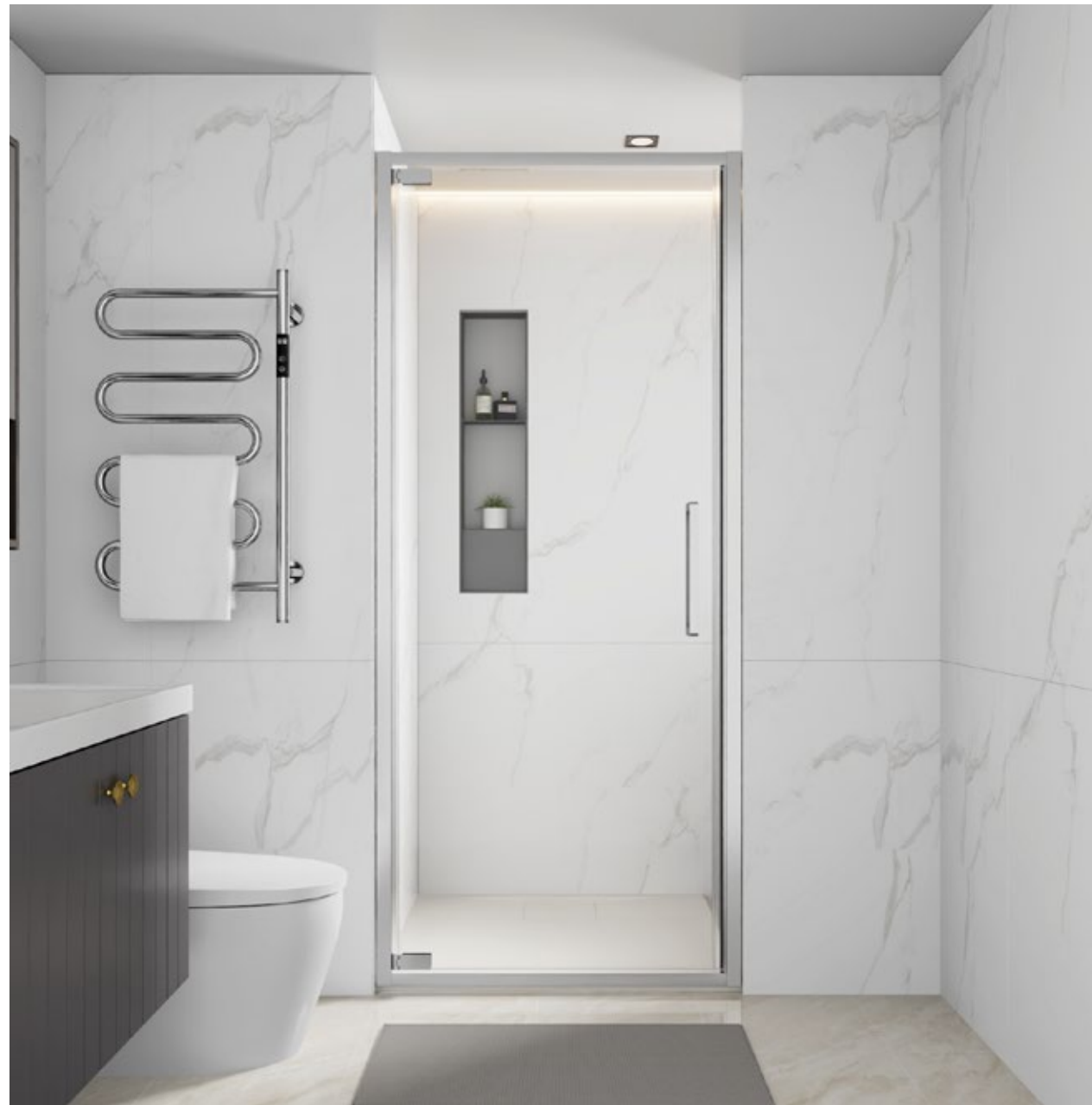

EI-P711

Width B	Product code	Adjustment min-max B	Door opening C
700	P711-A	680-700	552
760	P711-B	740-760	612
800	P711-C	780-800	652
900	P711-D	880-900	752

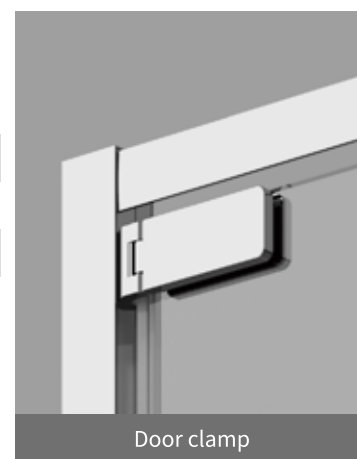
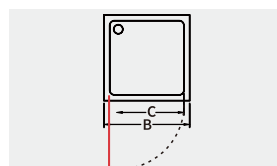

EI-P721

Width B	Product code	Adjustment min-max B	Door opening C
900	P721-A	880-900	539
1000	P721-B	980-1000	589
1100	P721-C	1080-1100	589
1200	P721-D	1180-1200	589
1400	P721-E	1380-1400	589
1500	P721-F	1480-1500	589
1600	P721-G	1580-1600	589
1700	P721-H	1680-1700	589

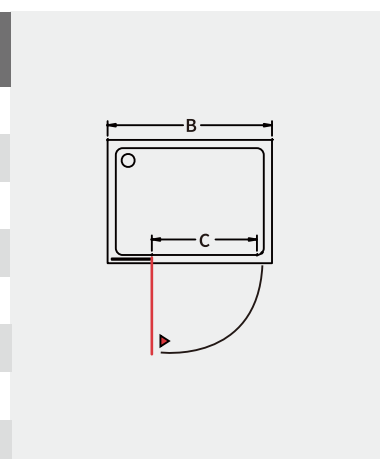



FRAME MATERIAL: Stainless steel frame

FRAME COLORS

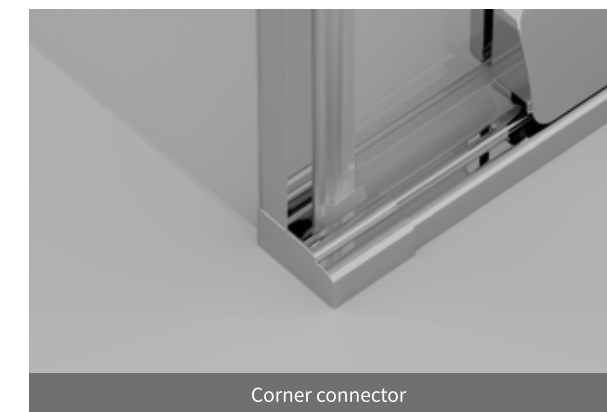
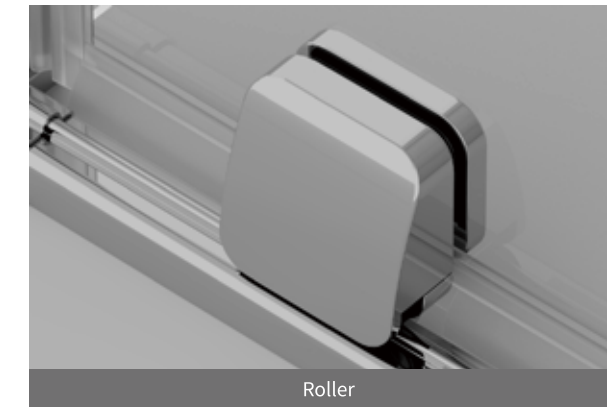

*Other handles are available. For more information, please see page 13.



FJ-S721

Width B	Product code	Adjustment min-max B	Door opening C
1000	S721-A	980-1000	406
1100	S721-B	1080-1100	456
1200	S721-C	1180-1200	506
1400	S721-D	1380-1400	606
1500	S721-E	1480-1500	656
1600	S721-F	1580-1600	706
1700	S721-G	1680-1700	756

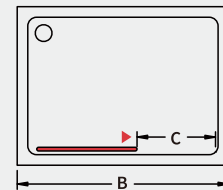

FJ-SP

Width B	Product code	Adjustment min-max B	Door opening C
700	SP-A	680-700	
800	SP-B	780-800	
900	SP-C	880-900	
1000	SP-D	980-1000	

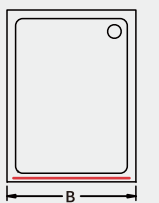



FJ-WALK-IN

Width B	Product code	Adjustment min-max B	Door opening C
1200	WALK-IN-A	1180-1200	570
1400	WALK-IN-B	1380-1400	670
1500	WALK-IN-C	1480-1500	720
1600	WALK-IN-D	1580-1600	720
1700	WALK-IN-E	1680-1700	720

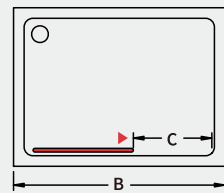

FJ-S142

Width B1/B2	Product code	Adjustment min-max B	Door opening C
800	S142-A	780-800	394
900	S142-B	880-900	465
1000	S142-C	980-1000	465

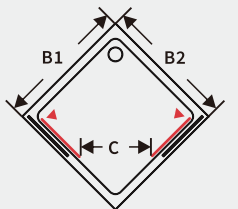



FRAME MATERIAL: Stainless steel frame

FRAME COLORS

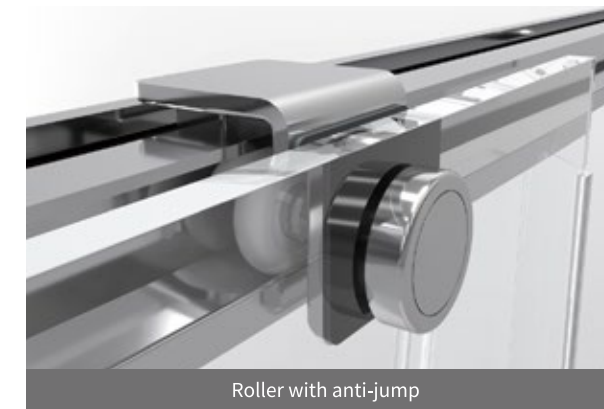

*Other handles are available. For more information, please see page 13.



FN-S721

Width B	Product code	Adjustment min-max B	Door opening C
1100	S721-A	1070-1100	410
1200	S721-B	1170-1200	460
1400	S721-C	1370-1400	610
1500	S721-D	1470-1500	610
1600	S721-E	1570-1600	610
1700	S721-F	1670-1700	610

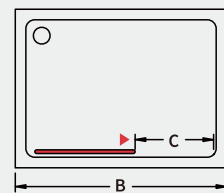

FN-SP

Width B	Product code	Adjustment min-max B	Door opening C
700	SP-A	675-690	
760	SP-B	735-750	
800	SP-C	775-790	
900	SP-D	885-890	

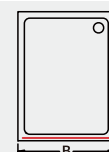

Corner connector



FN-P711b

Width B	Product code	Adjustment min-max B	Door opening C
700	P711b-A	680-695	555
760	P711b-B	740-755	615
800	P711b-C	780-795	655
900	P711b-D	880-895	755

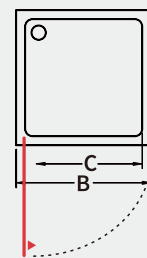

FN-P721

Width B	Product code	Adjustment min-max B	Door opening C
800	P721-A	780-795	520
900	P721-B	880-895	620
1000	P721-C	980-995	620
1200	P721-D	1180-1195	620
1400	P721-E	1380-1395	620

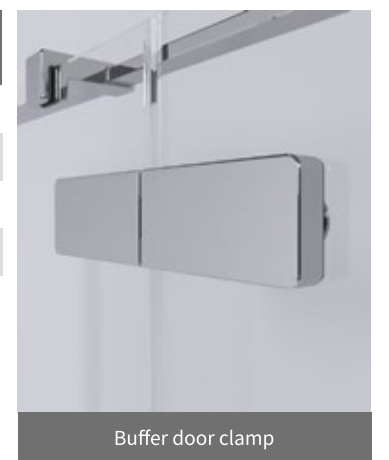
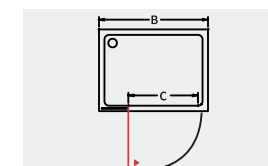

Buffer door clamp



FN-SP

Width B	Product code	Adjustment min-max B	Door opening C
700	SP-A	675-690	
760	SP-B	735-750	
800	SP-C	775-790	
900	SP-D	885-890	

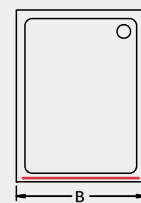

FN-S431

Width B1/B2	Product code	Adjustment min-max B	Door opening C
800/800	S431-A	770-785/770-785	410
900/900	S431-B	870-885/870-885	440
1000/1000	S431-C	970-985/970-985	440
800/1000	S431-D	770-785/970-985	440
800/1200	S431-E	770-785/1170-1185	440
900/1200	S431-F	870-885/1170-1185	440



Wall-to-rail connector



FN-P711a

Width B	Product code	Adjustment min-max B	Door opening C
700	P711a-A	670-700	450
760	P711a-B	730-760	510
800	P711a-C	770-800	550
900	P711a-D	870-900	650

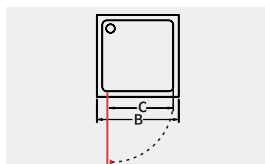

FN-SP

Width B	Product code	Adjustment min-max B	Door opening C
700	SP-A	675-690	
760	SP-B	735-750	
800	SP-C	775-790	
900	SP-D	885-890	

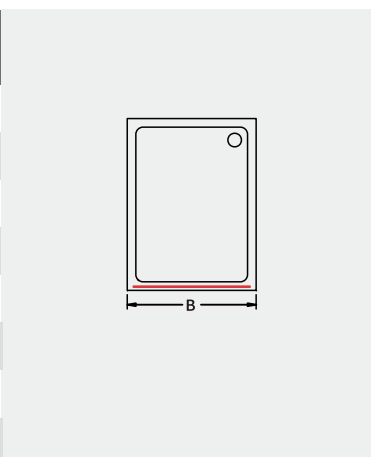



FRAME MATERIAL: Stainless steel frame



8
mm
GLASS
THICKNESS

↑
↓
HEIGHT
2000MM

15
mm
PRODUCT
ADJUSTMENT

↔
REVERSIBLE FOR
LEFT OR RIGHT

⬆
ALL SCREWS
ARE HIDDEN

*Other handles are available. For more information, please see page 13.



FN-B711

Width B	Product code	Adjustment min-max B	Door opening C
700	B711-A	670-700	605
760	B711-B	730-760	625
800	B711-C	770-800	645
900	B711-D	870-900	665

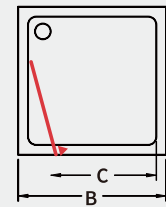

FN-SP

Width B	Product code	Adjustment min-max B	Door opening C
700	SP-A	675-690	
760	SP-B	735-750	
800	SP-C	775-790	
900	SP-D	885-890	

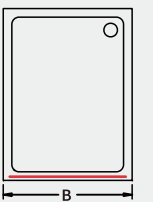

PATENT CERTIFICATE NUMBER



ZL202330208208.2
ZL202122258613.3



FRAME MATERIAL: Aluminum

FRAME COLORS

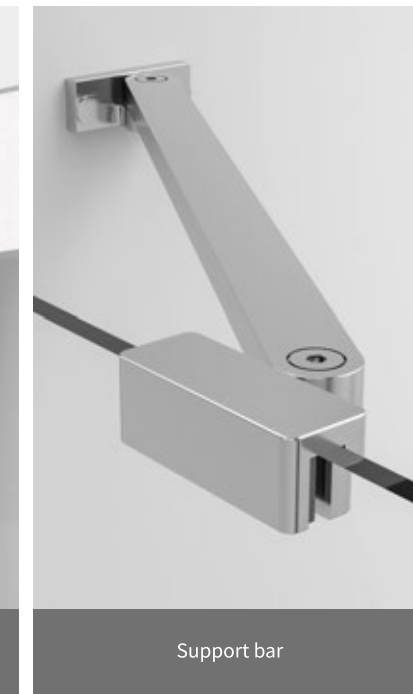
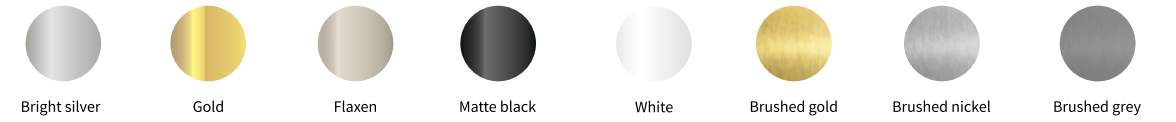

*Other handles are available. For more information, please see page 13.



AEN-P711

Width B	Product code	Adjustment min-max B	Door opening C
700	AEN-P711-A	680-700	610
760	AEN-P711-B	740-760	650
800	AEN-P711-C	780-800	710
900	AEN-P711-D	880-900	810

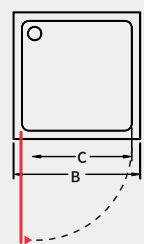

AEN-P721

Width B	Product code	Adjustment min-max B	Door opening C
900	AEN-P721-A	880-900	650
1000	AEN-P721-B	980-1000	650
1200	AEN-P721-C	1180-1200	650
1400	AEN-P721-D	1390-1400	650

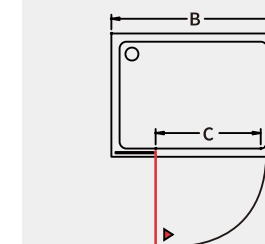



AEN - SP

Width B	Product code	Adjustment min-max B
700	AEN-SP-A	670-690
760	AEN-SP-B	730-750
800	AEN-SP-C	770-790
900	AEN-SP-D	870-890
1000	AEN-SP-E	970-990





AEN-P442

Width B1/B2	Product code	Adjustment min-max B1/B2	Door opening C
800 / 800	AEN-P442-A	780-790 / 780-790	680
900 / 900	AEN-P442-B	870-890 / 870-890	680
1000 / 1000	AEN-P442-C	970-990 / 970-990	680

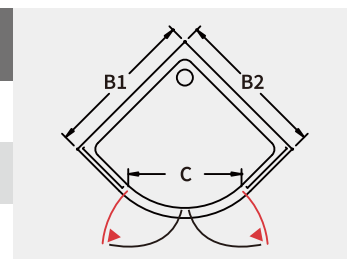

AEN - P142

Width B1/B2	Product code	Adjustment min-max B1/B2	Door opening C
800 / 800	AEN-P142-A	770-790 / 770-790	760
900 / 900	AEN-P142-B	870-890 / 870-890	760
1000 / 1000	AEN-P142-C	970-990 / 970-990	760

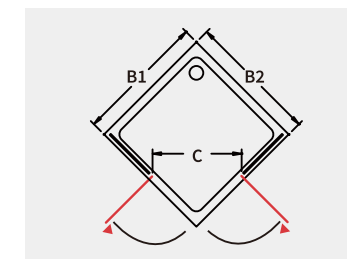



FRAME COLORS



FL-P711

Width B	Product code	Adjustment min-max B	Door opening C
700	P711-A	680-690	600
760	P711-B	740-750	660
800	P711-C	780-790	700
900	P711-D	980-990	800

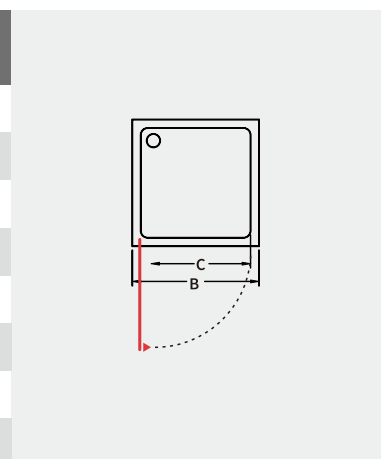

*Other handles are available. For more information, please see page 13.

**FAST
INSTALLATION**



FRAME MATERIAL: Aluminum

FRAME COLORS

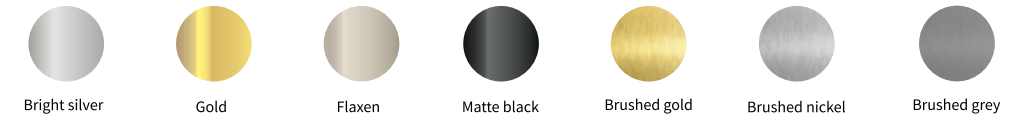

Hanging clamp detail image



S722 door bottom guide detail image



*Other handles are available. For more information, please see page 13.



90° positioning pivot design.

AY8-P721

Width B	Product code	Adjustment min-max B	Door opening C
900	AY8-P721-A	880-900	450
1000	AY8-P721-B	980-1000	450
1100	AY8-P721-C	1080-1100	450
1200	AY8-P721-D	1180-1200	500
1400	AY8-P721-E	1380-1400	600
1500	AY8-P721-F	1480-1500	650
1600	AY8-P721-G	1580-1600	700
1700	AY8-P721-H	1680-1700	750

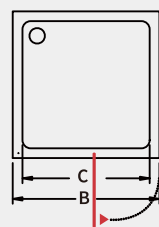

AY8-SP

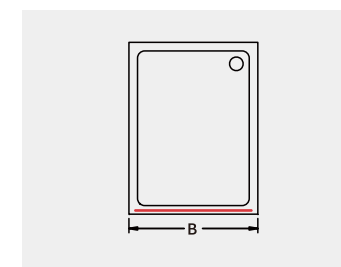

Width B	Product code	Adjustment min-max B
700	AY8-SP-A	680-700
760	AY8-SP-B	740-760
800	AY8-SP-C	780-800
900	AY8-SP-D	880-900
1000	AY8-SP-E	980-1000

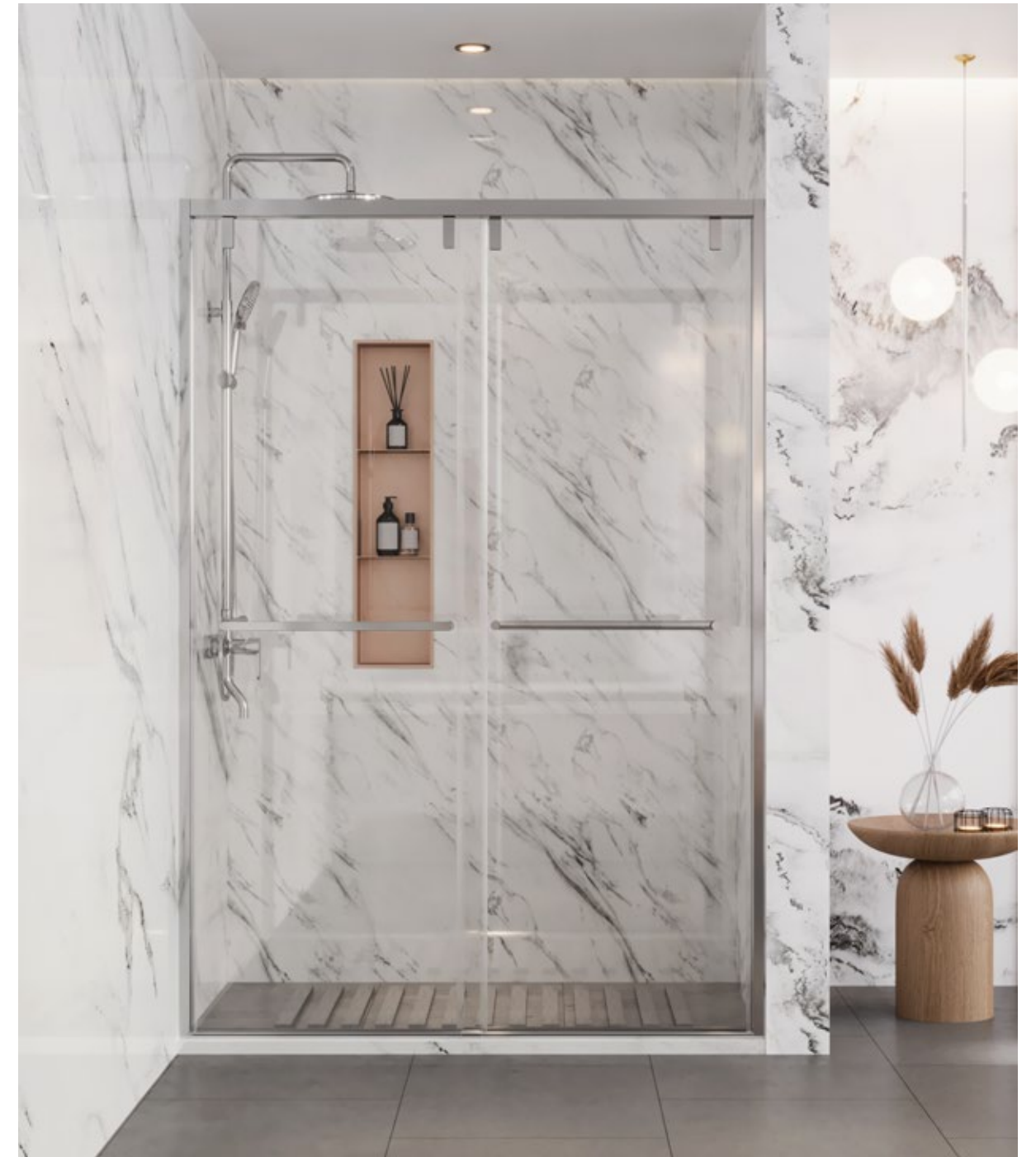

AY1-S721

Width B	Product code	Adjustment min-max B	Door opening C
900	AY1-S721-A	880-900	450
1000	AY1-S721-B	980-1000	450
1100	AY1-S721-C	1080-1100	450
1200	AY1-S721-D	1180-1200	500
1400	AY1-S721-E	1380-1400	600
1500	AY1-S721-F	1480-1500	650
1600	AY1-S721-G	1580-1600	700
1700	AY1-S721-H	1680-1700	750

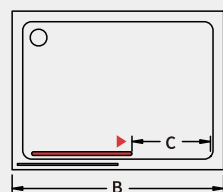

*AY2-S722 magnetic door closure for better waterproof performance.

AY2-S722

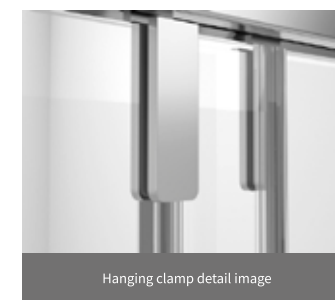

Hanging clamp detail image

Width B	Product code	Adjustment min-max B	Door opening C
48''(1219mm)	AY2-S722-A	1143-1219	489-565
60''(1524mm)	AY2-S722-B	1448-1524	639-715

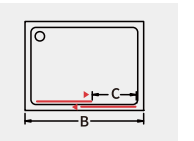



AY1/AY2-SP

Width B	Product code	Adjustment min-max B
700	AY1/AY2-SP-A	680-700
760	AY1/AY2-SP-B	740-760
800	AY1/AY2-SP-C	780-800
900	AY1/AY2-SP-D	880-900
1000	AY1/AY2-SP-E	980-1000

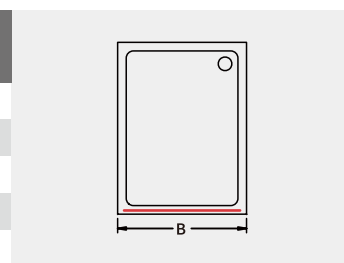

AY4-S442

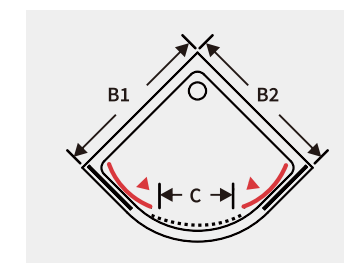

Width B1/B2	Product code	Adjustment min-max B1/B2	Door opening C
760 / 900	AY4-S442-A	745-760/885-900	550
800 / 800	AY4-S442-B	785-800/785-800	550
900 / 900	AY4-S442-C	885-900/885-900	550
1000 / 1000	AY4-S442-D	985-1000/985-1000	550
800 / 1000	AY4-S422-E	785-1000/785-1000	550
800 / 1200	AY4-S422-F	785-1200/785-1200	550
900 / 1200	AY4-S422-G	885-1200/885-1200	550



AY4-S721

Width B	Product code	Adjustment min-max B	Door opening C
900	AY4-S721-A	880-900	450
1000	AY4-S721-B	980-1000	450
1100	AY4-S721-C	1080-1100	450
1200	AY4-S721-D	1180-1200	500
1400	AY4-S721-E	1380-1400	600
1500	AY4-S721-F	1480-1500	650
1600	AY4-S721-G	1580-1600	700
1700	AY4-S721-H	1680-1700	750

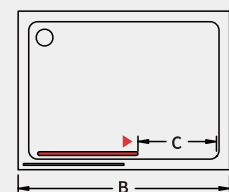

AY4-SP

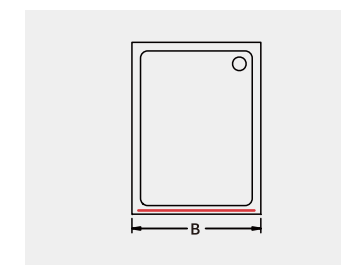

Width B	Product code	Adjustment min-max B
700	AY4-SP-A	680-700
760	AY4-SP-B	740-760
800	AY4-SP-C	780-800
900	AY4-SP-D	880-900
1000	AY4-SP-E	980-1000



FRAME MATERIAL: Aluminum

FRAME COLORS

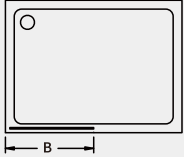

EH-YP-S722	Width B	Product code	Adjustment min-max B	Door opening C
	900	EH-YP-S722-A	885-900	835
	1000	EH-YP-S722-B	985-1000	935

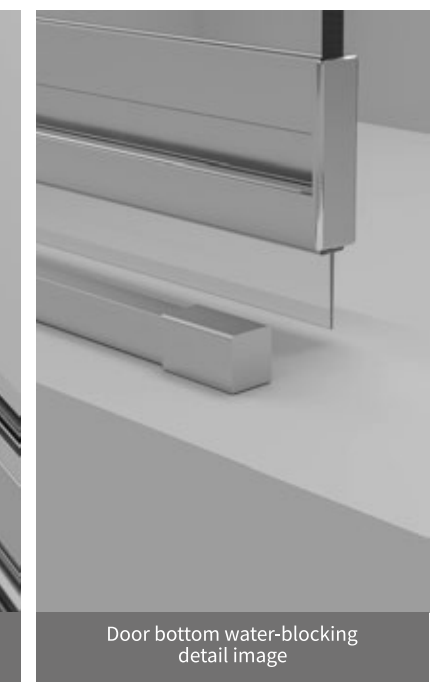
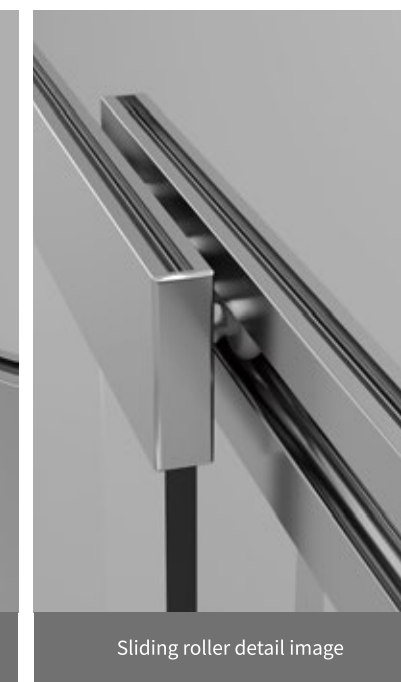

- 

6
mm
GLASS THICKNESS
- 

1500
mm
HEIGHT
- 

15
mm
PRODUCT ADJUSTMENT
- 

REVERSIBLE FOR LEFT OR RIGHT
- 

CONCEALED SLIDING ROLLER DESIGN

*Other handles are available. For more information, please see page 13.



FRAME MATERIAL: Aluminum

FRAME COLORS



EG-S331	Width B	Product code	Adjustment min-max B	Door opening C
	1000 * 1000	EG-S331	975-990	520



Closing mechanism detail image

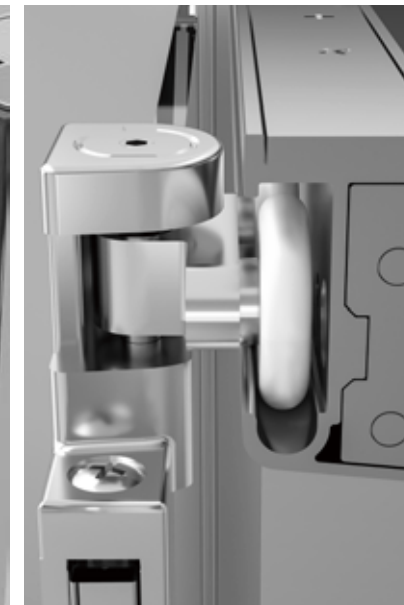

Roller detail image



Adjustment detail image

- 

8
mm
GLASS
THICKNESS
- 

2000
mm
HEIGHT
- 

15
mm
PRODUCT
ADJUSTMENT
- 

REVERSIBLE FOR
LEFT OR RIGHT
- 

MAGNETIC
CLOSURE

*Other handles are available. For more information, please see page 13.



EG-S121

Width B1 / B2	Product code	Adjustment min-max B	Door opening C
760 / 760	EG-S121-A	725-740	520
800 / 800	EG-S121-B	775-790	585
900 / 900	EG-S121-C	875-890	650

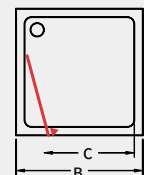

EG-S131

Width B	Product code	Adjustment min-max B	Door opening C
800 / 800	EG-S121-A	775-790	575
900 / 900	EG-S121-B	875-890	575
1000 / 1000	EG-S121-C	975-990	575

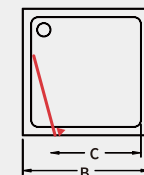



FRAME MATERIAL: Aluminium frame

FRAME COLORS



Buffer and roller

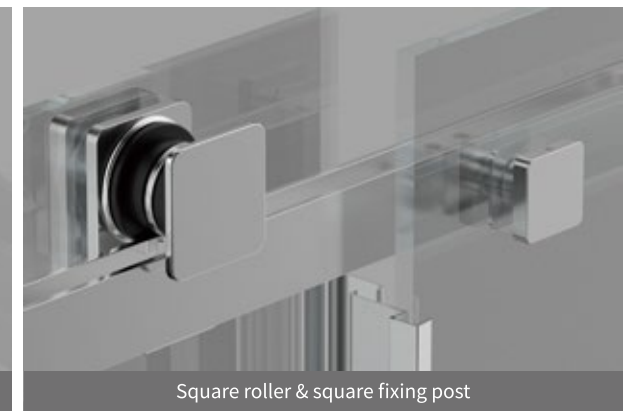

Square roller & square fixing post



Corner connector



*Other handles are available. For more information, please see page 13.



FM-S721

Width B	Product code	Adjustment min-max B	Door opening C
1000	S721-A	980-990	409
1100	S721-B	1080-1090	459
1200	S721-C	1180-1190	509
1400	S721-D	1380-1390	609
1500	S721-E	1480-1490	709
1600	S721-F	1580-1590	709
1700	S721-G	1680-1690	709

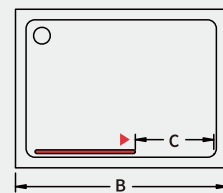

FM-SP

Width B	Product code	Adjustment min-max B	Door opening C
700	SP-A	690-800	
760	SP-B	750-760	
800	SP-C	790-800	
900	SP-D	890-900	
1000	SP-E	990-1000	

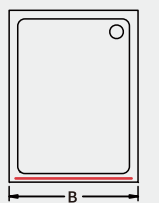



ZL202220458704.3

**FAST
INSTALLATION**



FRAME MATERIAL: Aluminum

FRAME COLORS

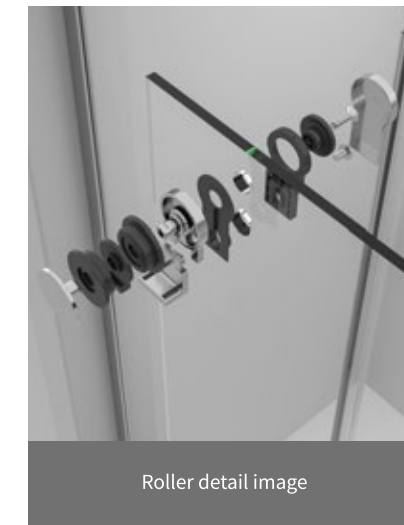

Roller detail image

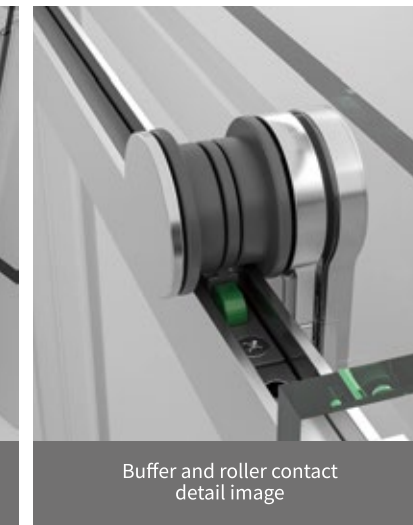

Buffer and roller contact detail image

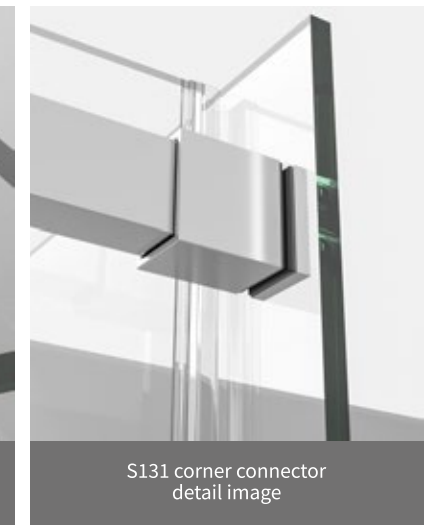

S131 corner connector detail image



*Other handles are available. For more information, please see page 13.



PH-S721

Width B	Product code	Adjustment min-max B	Door opening C
1100	PH-S721-A	1070-1090	452
1200	PH-S721-B	1170-1190	502
1400	PH-S721-C	1370-1390	602
1500	PH-S721-D	1470-1490	652
1600	PH-S721-E	1570-1590	652
1700	PH-S721-F	1670-1690	652

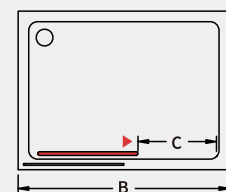

PH-SP

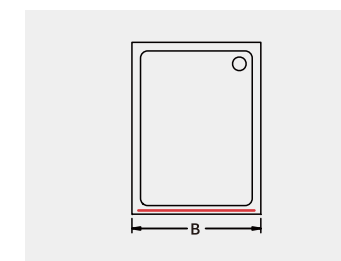

Width B	Product code	Adjustment min-max B
700	PH-SP-A	675-690
760	PH-SP-B	735-750
800	PH-SP-C	775-790
900	PH-SP-D	875-890
1000	PH-SP-E	975-990



FRAME MATERIAL: Aluminium frame or Stainless steel frame

FRAME COLORS

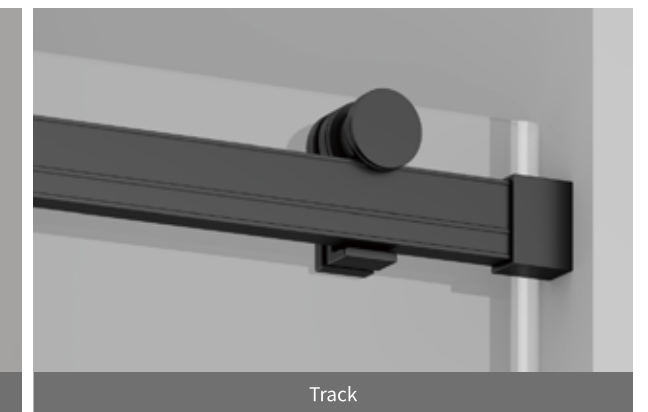
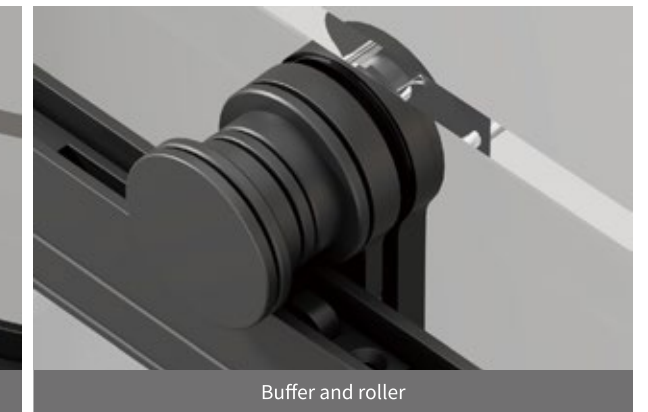
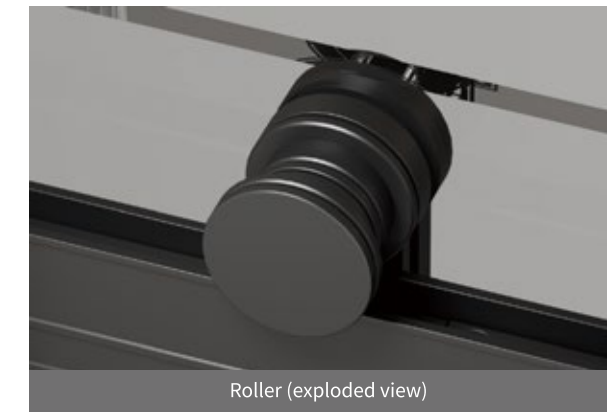

- 

8
mm
GLASS
THICKNESS
- 

HEIGHT
2000MM
- 

15
mm
PRODUCT
ADJUSTMENT
- 

REVERSIBLE FOR
LEFT OR RIGHT
- 

ALL SCREWS
ARE HIDDEN

*Other handles are available. For more information, please see page 13.



FR-S721

Width B	Product code	Adjustment min-max B	Door opening C
1000	S721-A	980-990	409
1100	S721-B	1080-1090	459
1200	S721-C	1180-1190	509
1400	S721-D	1380-1390	609
1500	S721-E	1480-1490	709
1600	S721-F	1580-1590	709
1700	S721-G	1680-1690	709

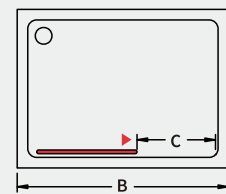

FR-SP

Width B	Product code	Adjustment min-max B	Door opening C
700	SP-A	690-800	
760	SP-B	750-760	
800	SP-C	790-800	
900	SP-D	890-900	
1000	SP-E	990-1000	

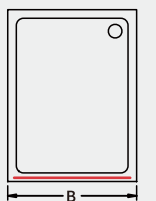

**FAST
INSTALLATION**



FRAME MATERIAL: Aluminum

FRAME COLORS

- 
Bright silver
- 
Gold
- 
Flaxen
- 
Matte black
- 
Brushed gold
- 
Brushed nickel
- 
Brushed grey



Roller detail image

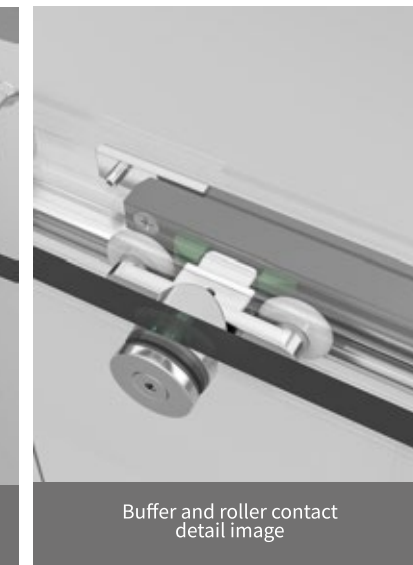

Buffer and roller contact detail image



Pivot structure

- 
GLASS THICKNESS
- 
HEIGHT 2000MM
- 
PRODUCT ADJUSTMENT
- 
REVERSIBLE FOR LEFT OR RIGHT
- 
ALL SCREWS ARE HIDDEN
- 
SOFT CLOSE
- 
FAST INSTALLATION

*Other handles are available. For more information, please see page 13.



CG-S721

Width B	Product code	Adjustment min-max B	Door opening C
1000	CG-S721-A	975-990	389
1100	CG-S721-B	1075-1190	439
1200	CG-S721-C	1175-1190	489
1400	CG-S721-D	1375-1390	589
1500	CG-S721-E	1475-1490	639
1600	CG-S721-F	1575-1590	639
1700	CG-S721-G	1675-1690	639

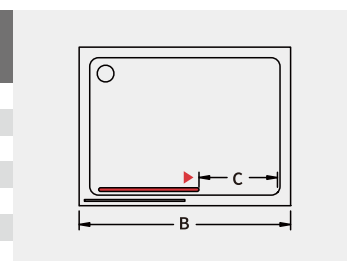

CG-SP

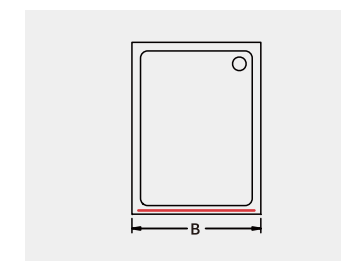

Width B	Product code	Adjustment min-max B
700	CG-SP-A	675-690
760	CG-SP-B	735-750
800	CG-SP-C	775-790
900	CG-SP-D	875-890
1000	CG-SP-E	975-990



FRAME MATERIAL: Aluminium frame

FRAME COLORS



Corner connector

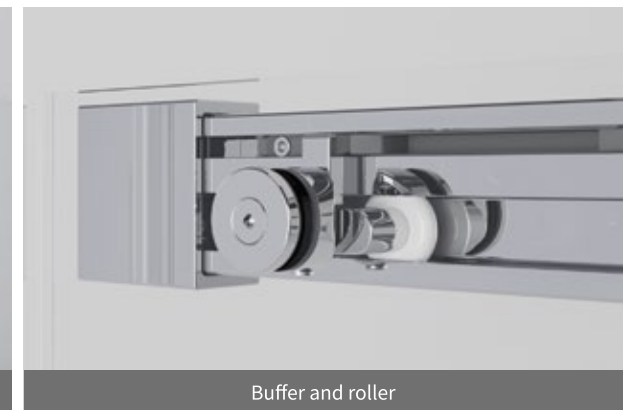

Buffer and roller



*Other handles are available. For more information, please see page 13.



DU-S721

Width B	Product code	Adjustment min-max B	Door opening C
1000	S721-A	985-1000	389
1100	S721-B	1085-1100	439
1200	S721-C	1185-1200	489
1400	S721-D	1385-1400	589
1500	S721-E	1485-1500	589
1600	S721-F	1585-1600	589
1700	S721-G	1685-1700	589

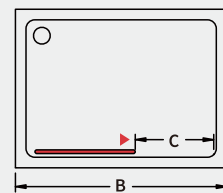

DU-SP

Width B	Product code	Adjustment min-max B	Door opening C
700	SP-A	685-700	
760	SP-B	745-760	
800	SP-C	785-800	
900	SP-D	885-900	
1000	SP-E	985-1000	

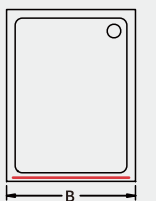



FRAME MATERIAL: Aluminium frame

FRAME COLORS

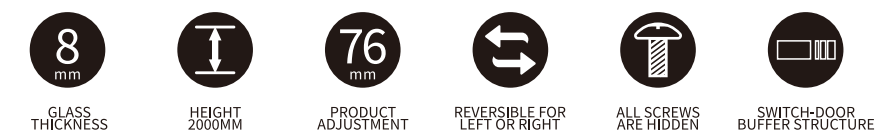

*Other handles are available. For more information, please see page 13.



EY-S721

Width B	Product code	Adjustment min-max B	Door opening C
1000	S721-A	985-1000	410
1100	S721-B	1085-1100	460
1200	S721-C	1185-1200	610
1400	S721-D	1385-1400	610
1500	S721-E	1485-1500	610
1600	S721-F	1585-1600	610
1700	S721-G	1685-1700	610

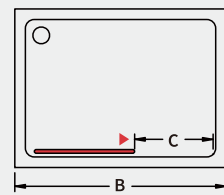

EY-SP

Width B	Product code	Adjustment min-max B	Door opening C
700	SP-A	675-690	
760	SP-B	735-750	
800	SP-C	775-790	
900	SP-D	875-890	

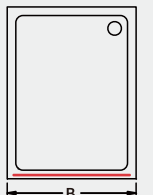



FRAME MATERIAL: Aluminum

FRAME COLORS



PF-S721	Width B	Product code	Adjustment min-max B	Door opening C
	1000	PF-S721-A	970-990	390
	1100	PF-S721-B	1070-1090	440
	1200	PF-S721-C	1170-1190	490
	1400	PF-S721-D	1370-1390	590
	1500	PF-S721-E	1470-1490	590
	1600	PF-S721-F	1570-1590	590
	1700	PF-S721-G	1670-1690	590

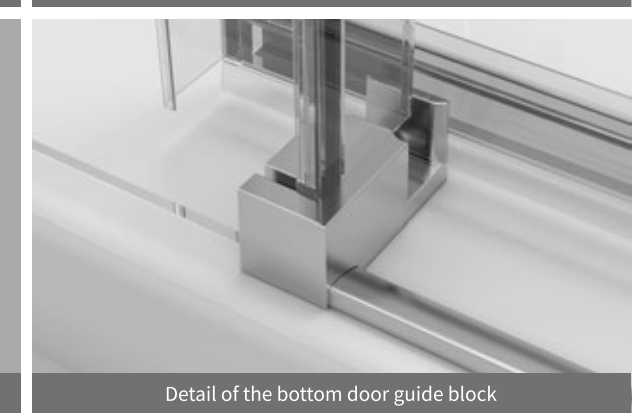
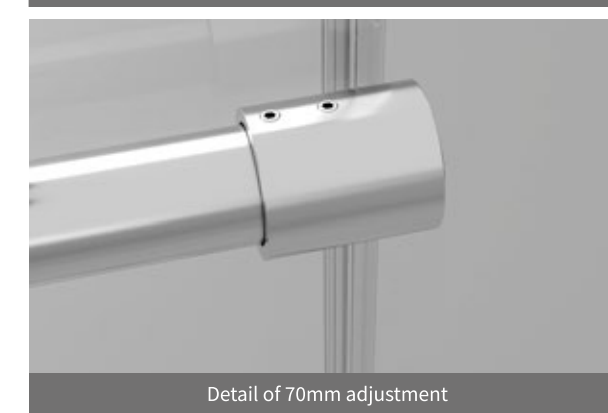
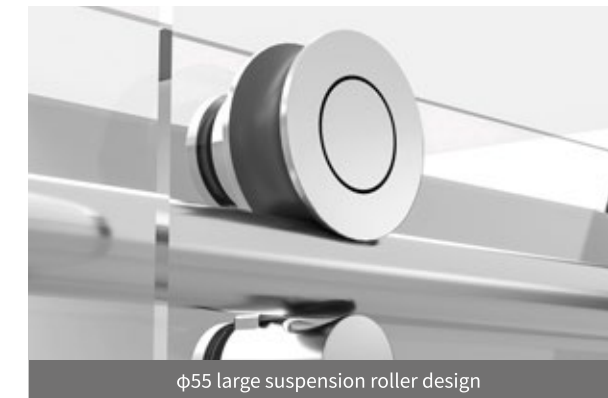

*Optional configurations:
 ① Easy installation and cleaning structure design.
 ② Switch-door buffer structure.

*Other handles are available. For more information, please see page 13.



FRAME MATERIAL: Stainless steel frame

FRAME COLORS

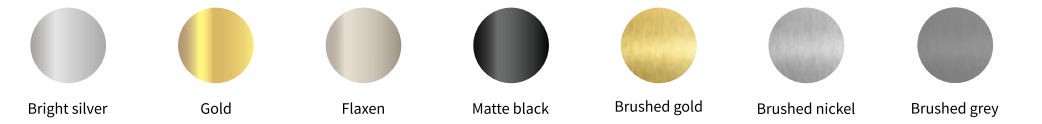

FZ-S721

Width B	Product code	Adjustment min-max B	Door opening C
1000	S721-A	985-1000	428
1100	S721-B	1085-1100	478
1200	S721-C	1185-1200	528
1400	S721-D	1385-1400	578
1500	S721-E	1485-1500	578
1600	S721-F	1585-1600	578
1700	S721-G	1685-1700	578

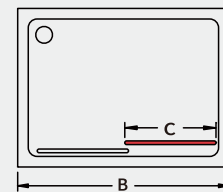

GLASS THICKNESS



HEIGHT 2000MM



PRODUCT ADJUSTMENT



REVERSIBLE FOR LEFT OR RIGHT



ALL SCREWS ARE HIDDEN



SWITCH-DOOR BUFFER STRUCTURE

FZ-SP

Width B	Product code	Adjustment min-max B	Door opening C
700	SP-A	675-690	
760	SP-B	735-750	
800	SP-C	775-790	
900	SP-D	875-890	

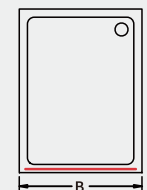

*Other handles are available. For more information, please see page 13.



ZL201922278181.5



FRAME MATERIAL: Aluminum

FRAME COLORS



DH-S721	Width B	Product code	Adjustment min-max B	Door opening C
	1000	DH-S721-A	940-1000	350-410
	1100	DH-S721-B	1040-1100	400-460
	1200	DH-S721-C	1140-1200	450-510
	1400	DH-S721-D	1340-1400	500-560
	1500	DH-S721-E	1440-1500	550-610
	1600	DH-S721-F	1540-1600	600-660
	1700	DH-S721-G	1640-1700	650-710

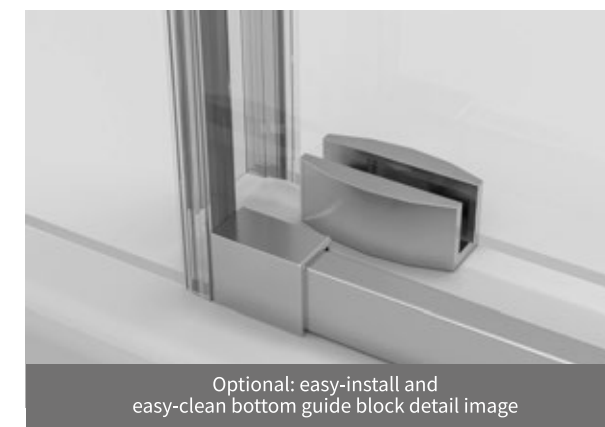
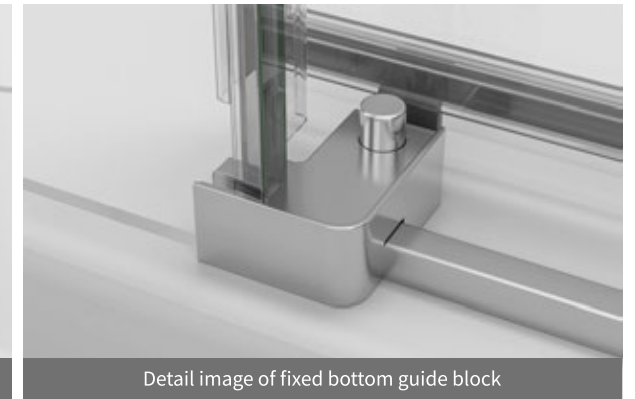

- 10**
mm
GLASS THICKNESS
- 2000**
mm
HEIGHT
- 76**
mm
PRODUCT ADJUSTMENT
- ↔**
REVERSIBLE FOR LEFT OR RIGHT
- ⌘**
ALL SCREWS ARE HIDDEN
- ⊙**
φ70 SUSPENSION ROLLER

*Optional configurations:
1. Easy-installation and easy-cleaning structural design.
2. Switch-door buffer structure.

*Other handles are available. For more information, please see page 13.



FRAME MATERIAL: Aluminium frame

FRAME COLORS



ES-S722

Width B	Product code	Adjustment min-max B	Door opening C
1000	S722-A	995-1000	427
1100	S722-B	1095-1100	477
1200	S722-C	1195-1200	527
1300	S722-D	1295-1300	577
1400	S722-E	1395-1400	627
1500	S722-F	1495-1500	677

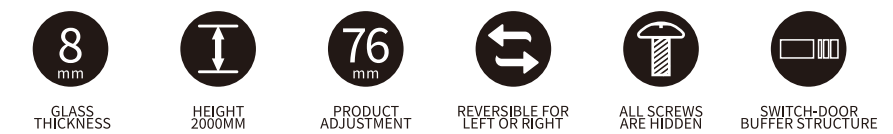
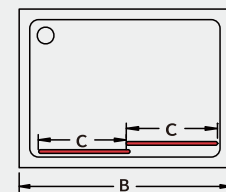

*Other handles are available. For more information, please see page 13.



FRAME MATERIAL: Aluminum

FRAME COLORS

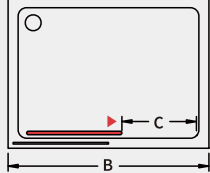

DE-S722	Width B	Product code	Adjustment min-max B	Door opening C
	48"(1219mm)	DE-S722-A	1143-1219	489-565
	60"(1524mm)	DE-S722-B	1448-1524	639-715



Close-door clamp detail image

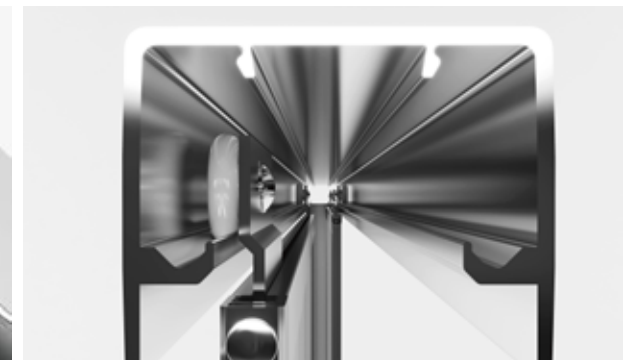

Upper rail cross-section detail image



Bottom guide block detail image

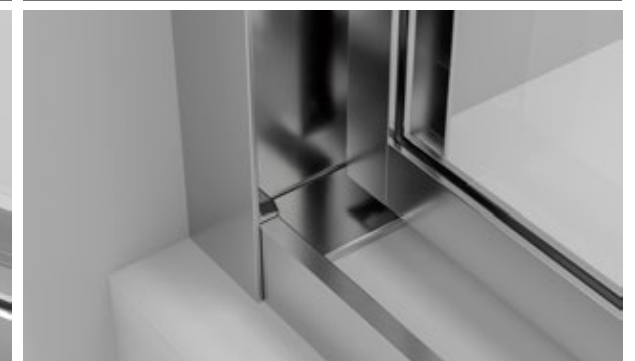

Plastic cover design detail at the bottom rail and vertical material connection

- 
GLASS THICKNESS
- 
HEIGHT 2000MM
- 
PRODUCT ADJUSTMENT
- 
REVERSIBLE FOR LEFT OR RIGHT
- 
ALL SCREWS ARE HIDDEN
- 
GLASS FRAME DESIGN

*Other handles are available. For more information, please see page 13.



FRAME MATERIAL: Aluminum or Stainless steel frame

FRAME COLORS

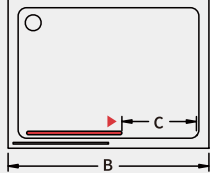

DC-S722	Width B	Product code	Adjustment min-max B	Door opening C
	48"(1219mm)	DC-S722-A	1143-1219	489-565
	60"(1524mm)	DC-S722-B	1448-1524	639-715

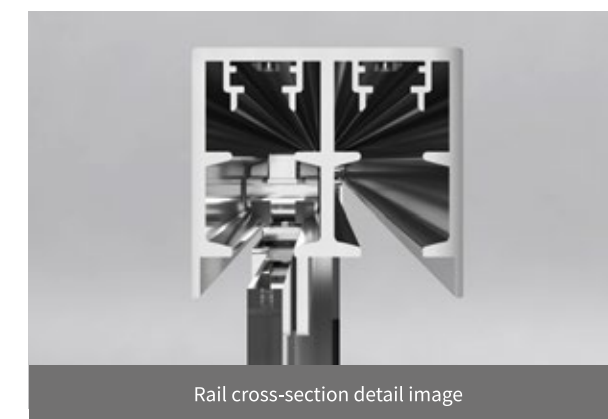
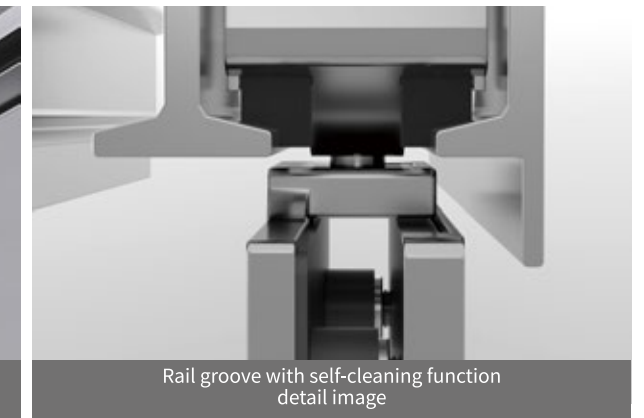

- 
8
mm
GLASS
THICKNESS
- 
HEIGHT
2000MM
- 
76
mm
PRODUCT
ADJUSTMENT
- 
REVERSIBLE FOR
LEFT OR RIGHT
- 
ALL SCREWS
ARE HIDDEN
- 
SOFT CLOSE

*Other handles are available. For more information, please see page 13.



FRAME MATERIAL: Aluminum

FRAME COLORS

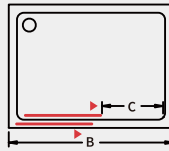

PB-S722	Width B	Product code	Adjustment min-max B	Door opening C
	48''(1219mm)	PB-S722-A	1143-1219	489-565
	60''(1524mm)	PB-S722-B	1448-1524	639-715

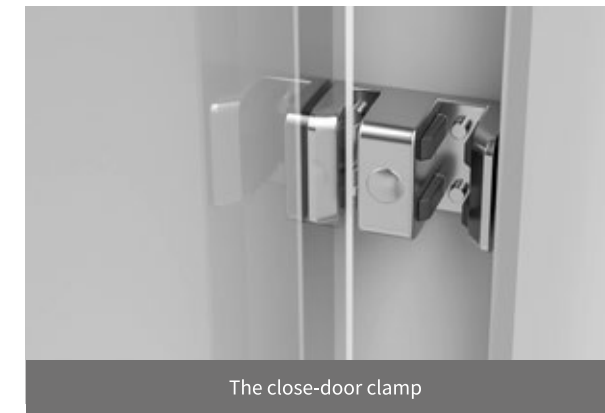

The close-door clamp

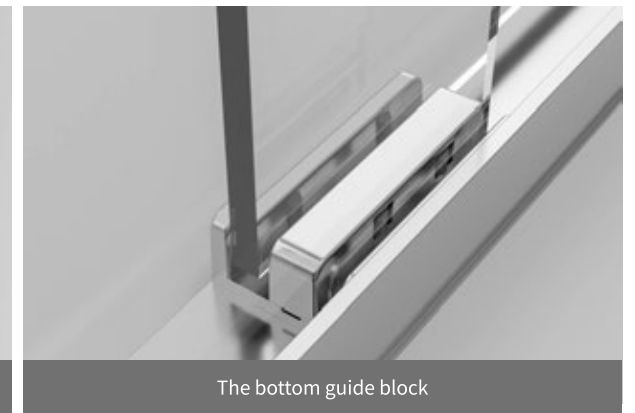

The bottom guide block



The upper rail cross-section



The plastic cover design at the connection between the bottom rail and vertical profile.

- 
GLASS THICKNESS
- 
HEIGHT 2000MM
- 
PRODUCT ADJUSTMENT
- 
REVERSIBLE FOR LEFT OR RIGHT
- 
ALL SCREWS ARE HIDDEN

*Other handles are available. For more information, please see page 13.



FRAME MATERIAL: Aluminum

FRAME COLORS

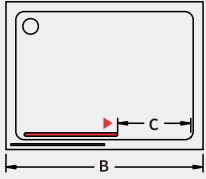

CV-S722	Width B	Product code	Adjustment min-max B	Door opening C
	48"(1219mm)	CV-S722-A	1143-1219	489-565
	60"(1524mm)	CV-S722-B	1448-1524	639-715

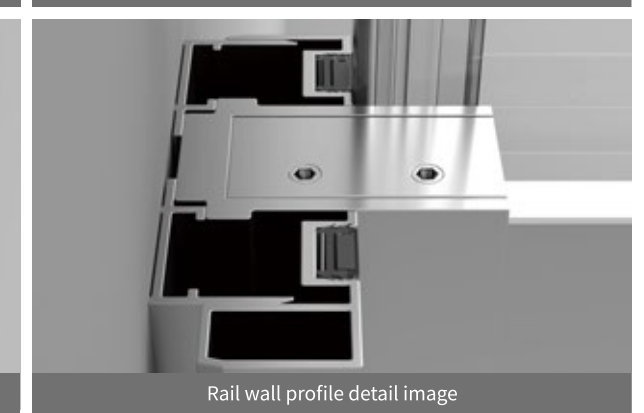
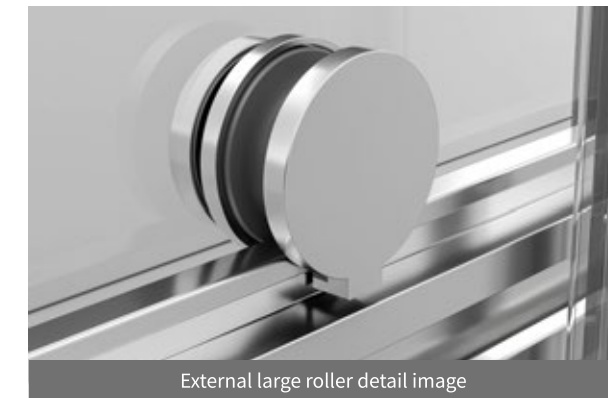

- 
GLASS THICKNESS
- 
HEIGHT 2000MM
- 
PRODUCT ADJUSTMENT
- 
REVERSIBLE FOR LEFT OR RIGHT
- 
ALL SCREWS ARE HIDDEN

***Optional configurations:**
Frameless (wall profile-free) design. Clamp closure mechanism.

*Other handles are available. For more information, please see page 13.



FRAME MATERIAL: Aluminium frame

FRAME COLORS

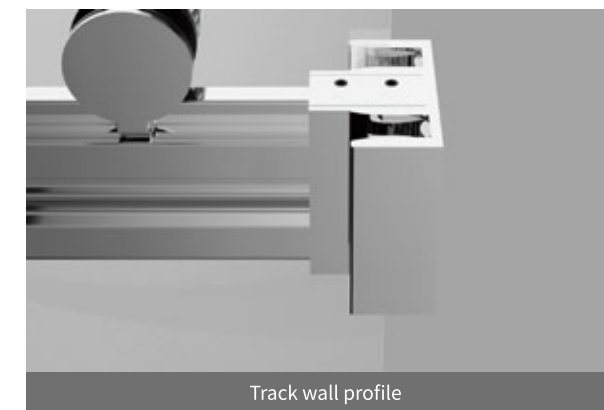
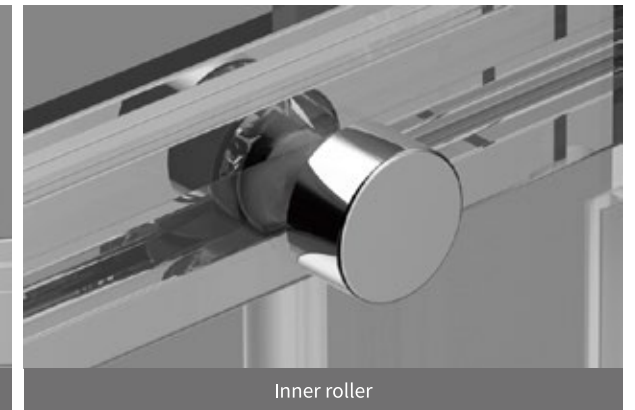

FS-S722

Width B	Product code	Adjustment min-max B	Door opening C
1000	S722-A	980-1000	450
1100	S722-B	1080-1100	500
1200	S722-C	1180-1200	550
1300	S722-D	1280-1300	600
1400	S722-E	1380-1400	650
1500	S722-F	1480-1500	700

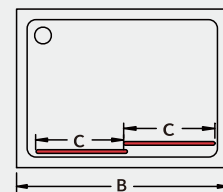

- 8**
mm
GLASS THICKNESS
- ↑**
HEIGHT
2000MM
- 76**
mm
PRODUCT ADJUSTMENT
- ↔**
REVERSIBLE FOR LEFT OR RIGHT
- ⌘**
ALL SCREWS ARE HIDDEN
- ⌘**
SWITCH-DOOR BUFFER STRUCTURE

*Other handles are available. For more information, please see page 13.



FRAME MATERIAL: Aluminium frame

FRAME COLORS

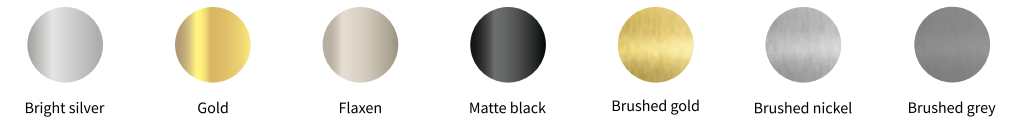

Outer large hanging roller



Inner roller



Track wall profile

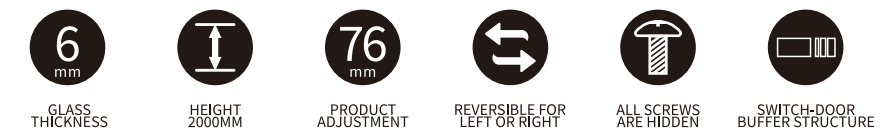

*Other handles are available. For more information, please see page 13.



FH-S722

Width B	Product code	Adjustment min-max B	Door opening C
1000	S722-A	980-1000	460
1100	S722-B	1080-1100	510
1200	S722-C	1180-1200	560
1300	S722-D	1280-1300	610
1400	S722-E	1380-1400	660
1500	S722-F	1480-1500	710

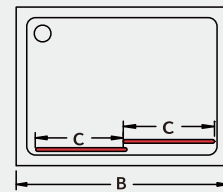

FH-SP

Width B	Product code	Adjustment min-max B	Door opening C
700	SP-A	680-690	
800	SP-B	740-750	
900	SP-C	780-790	
1000	SP-D	980-990	

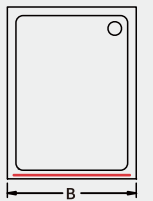



FRAME MATERIAL: Stainless steel frame

FRAME COLORS



Outer large hanging roller



Inner roller



Wall clamp block

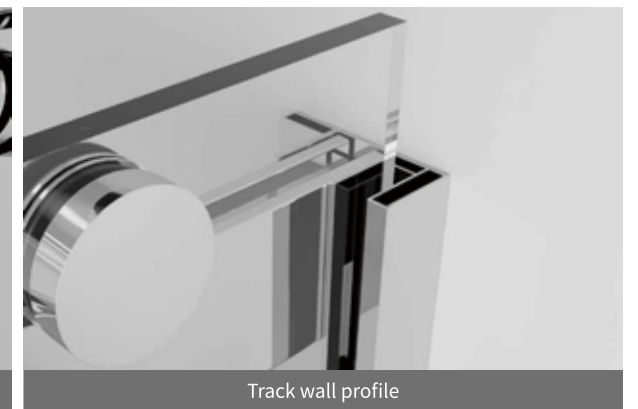

Track wall profile

PP-S722-A

Width B	Product code	Adjustment min-max B	Door opening C
1000	S722-A-A	980-1000	426
1100	S722-A-B	1080-1100	476
1200	S722-A-C	1180-1200	526
1300	S722-A-D	1280-1300	576
1400	S722-A-E	1380-1400	626
1500	S722-A-F	1480-1500	676

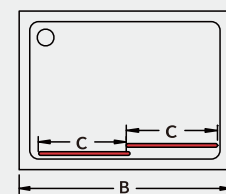



*Other handles are available. For more information, please see page 13.



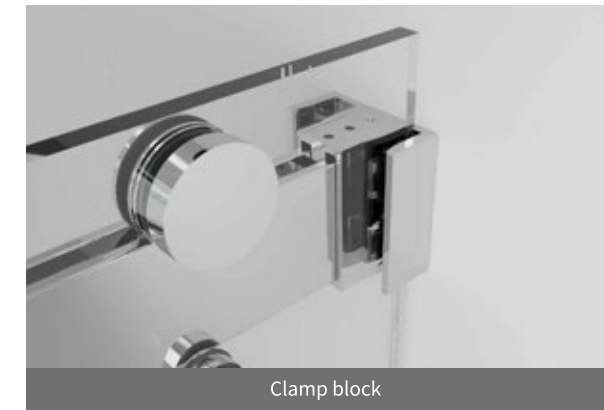

FRAME MATERIAL: Stainless steel frame

FRAME COLORS





- 

10
mm
GLASS
THICKNESS
- 

HEIGHT
2000MM
- 

76
mm
PRODUCT
ADJUSTMENT
- 

REVERSIBLE FOR
LEFT OR RIGHT
- 

ALL SCREWS
ARE HIDDEN
- 

SWITCH-DOOR
BUFFER STRUCTURE

*Other handles are available. For more information, please see page 13.



PP-S722-B

Width B	Product code	Adjustment min-max B	Door opening C
1000	S722-B-A	980-1000	460
1100	S722-B-B	1080-1100	510
1200	S722-B-C	1180-1200	560
1300	S722-B-D	1280-1300	610
1400	S722-B-E	1380-1400	660
1500	S722-B-F	1480-1500	710

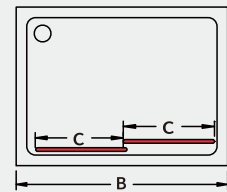

PP-SP

Width B	Product code	Adjustment min-max B	Door opening C
700	SP-A	680-690	
800	SP-B	740-750	
900	SP-C	780-790	
1000	SP-D	980-990	

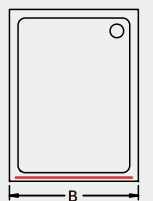



FRAME MATERIAL: Stainless steel frame

FRAME COLORS

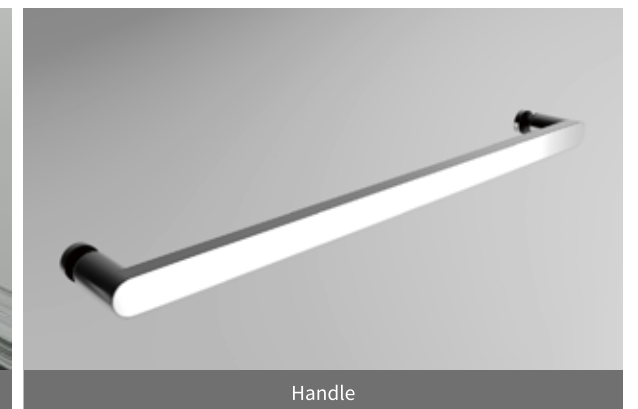
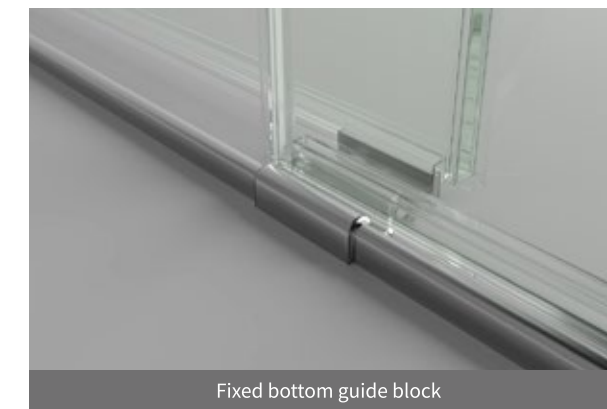

GB-S722

Width B	Product code	Adjustment min-max B	Door opening C
1000	S722-A	980-1000	460
1100	S722-B	1080-1100	510
1200	S722-C	1180-1200	560
1300	S722-D	1280-1300	610
1400	S722-E	1380-1400	660
1500	S722-F	1480-1500	710

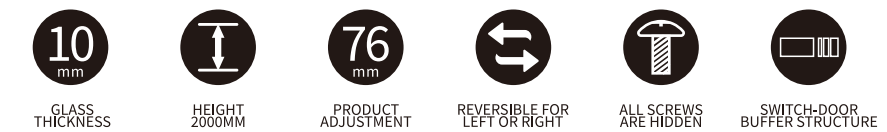
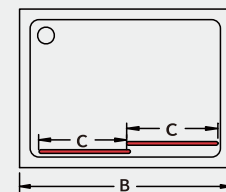



FRAME MATERIAL: Stainless steel

FRAME COLORS



Detail images of the front door clamp

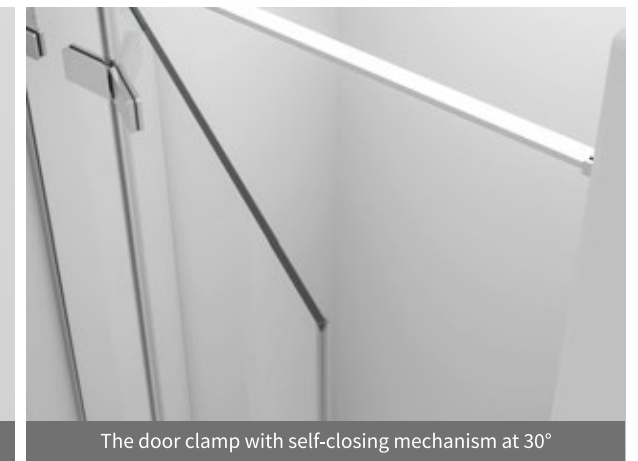

The door clamp with self-closing mechanism at 30°



Detail image of the P711 door clamp



Detail image of the support bar glass clamp



*Other handles are available. For more information, please see page 13.

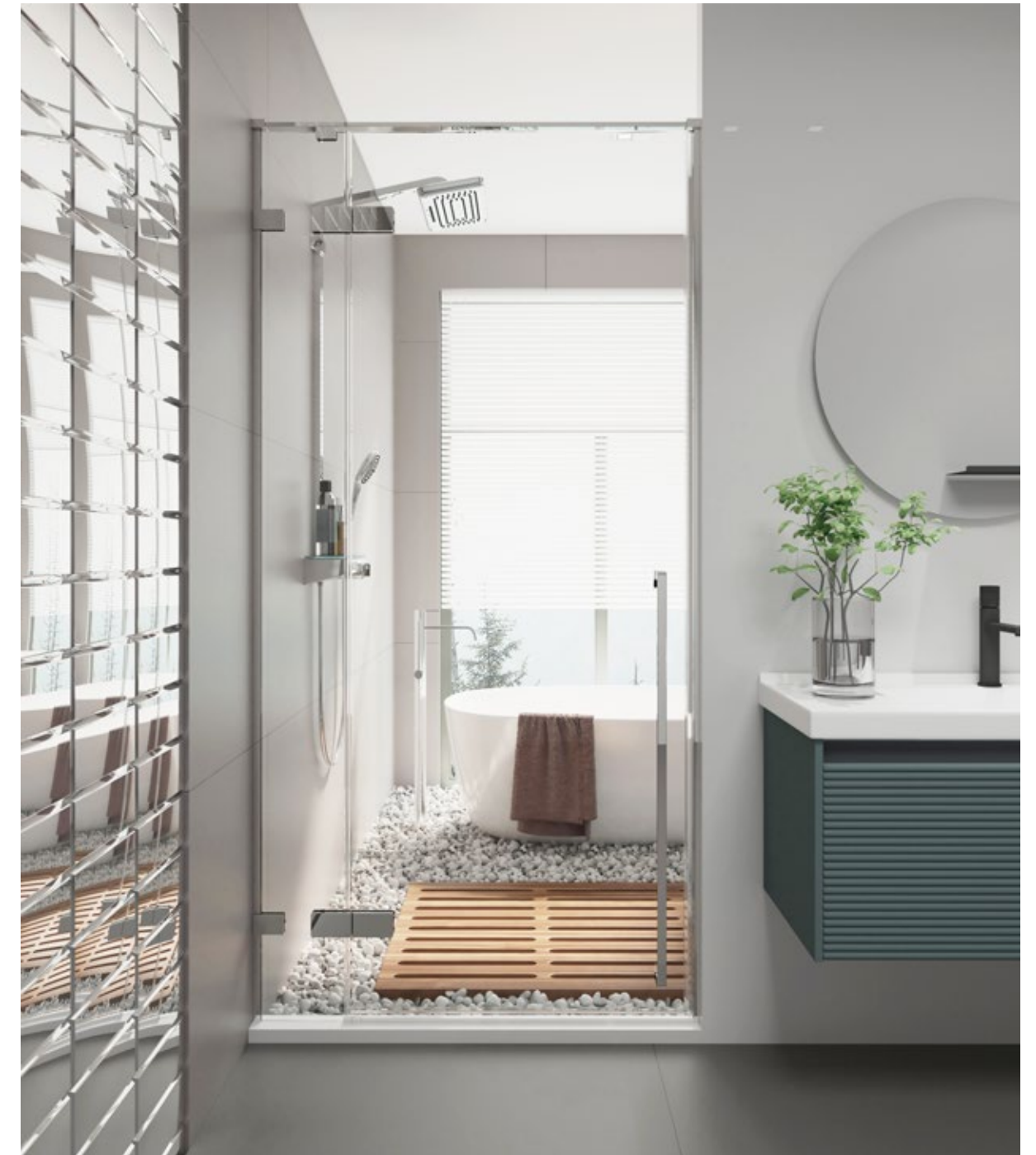

DV-P711

Width B	Product code	Adjustment min-max B	Door opening C
700	DV-P11-A	690-700	605
760	DV-P11-B	750-760	665
800	DV-P11-C	790-800	705
900	DV-P11-D	890-900	805

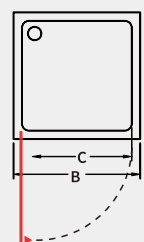

DV-P721

Width B	Product code	Adjustment min-max B	Door opening C
1000	DV-P721-B	990-1000	715
1100	DV-P721-C	1090-1100	715
1200	DV-P721-D	1190-1200	715
1400	DV-P721-E	1390-1400	715
1500	DV-P721-F	1490-1500	715
1600	DV-P721-G	1590-1600	715
1700	DV-P721-H	1690-1700	715

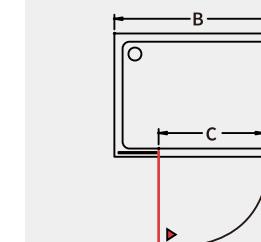



DV-SP

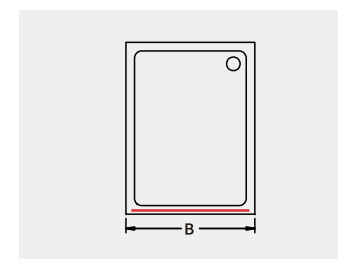

Width B	Product code	Adjustment min-max B
700	DV-SP-A	690-700
760	DV-SP-B	750-760
800	DV-SP-C	790-800
900	DV-SP-D	890-900
1000	DV-SP-E	990-1000

FRAME MATERIAL: Aluminium frame

FRAME COLORS



*Other handles are available. For more information, please see page 13.



CI-P721

Width B	Product code	Adjustment min-max B	Door opening C
1200	P721-C	1185-1200	595
1400	P721-D	1385-1400	595
1500	P721-E	1485-1500	595
1600	P721-F	1585-1600	595
1700	P721-G	1685-1700	595

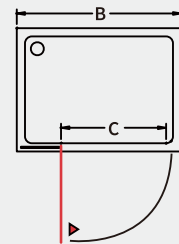

CI-P731

Width B	Product code	Adjustment min-max B	Door opening C
1000	P731-A	985-1000	595
1100	P731-B	1085-1100	595
1200	P731-C	1185-1200	595
1400	P731-D	1385-1400	595
1500	P731-E	1485-1500	595
1600	P731-F	1585-1600	595
1700	P731-G	1685-1700	595

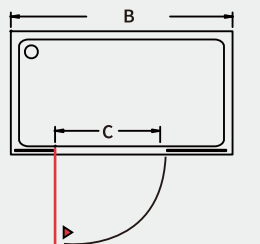



CI-P142

Width B1/B2	Product code	Adjustment min-max B	Door opening C
800	P142-A	785-800	709
900	P142-B	885-900	850
1000	P142-C	985-1000	850

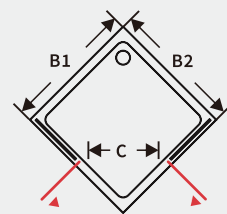

CI-P331

Width B	Product code	Adjustment min-max B	Door opening C
900	P331-A	885-900	607
1000	P331-B	985-1000	607

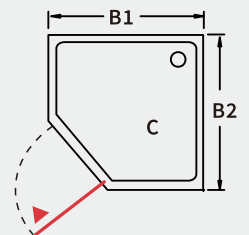



CI-SP-A

Width B	Product code	Adjustment min-max B	Door opening C
700	SP-A-A	685-700	
760	SP-A-B	745-760	
800	SP-A-C	785-800	
900	SP-A-D	885-900	
1000	SP-A-E	985-1000	



CI-SP-B

Width B	Product code	Adjustment min-max B	Door opening C
700	SP-B-A	685-700	
760	SP-B-B	745-760	
800	SP-B-C	785-800	
900	SP-B-D	885-900	
1000	SP-B-E	985-1000	



FRAME MATERIAL: Aluminum

FRAME COLORS

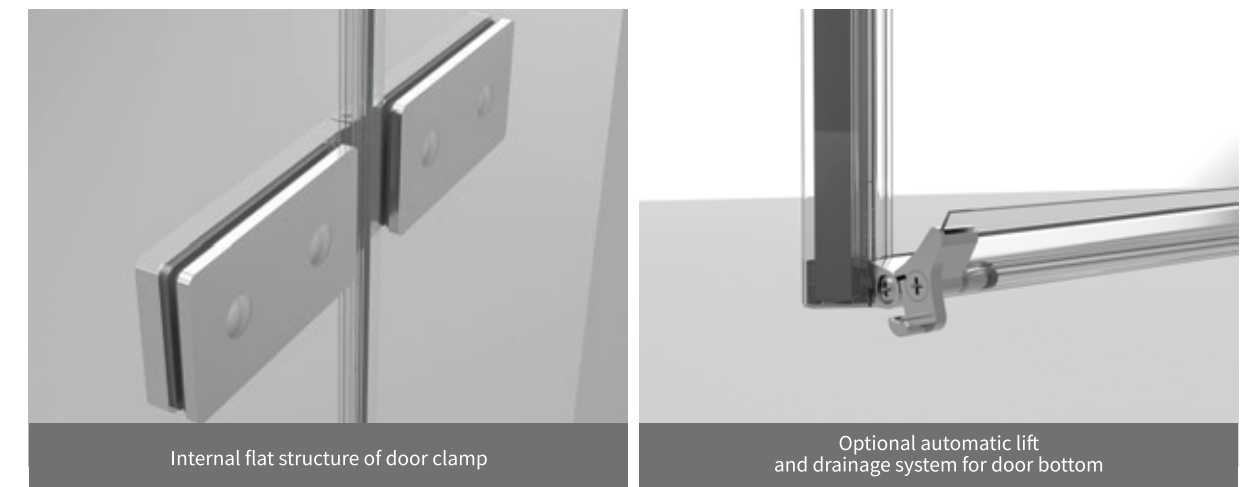
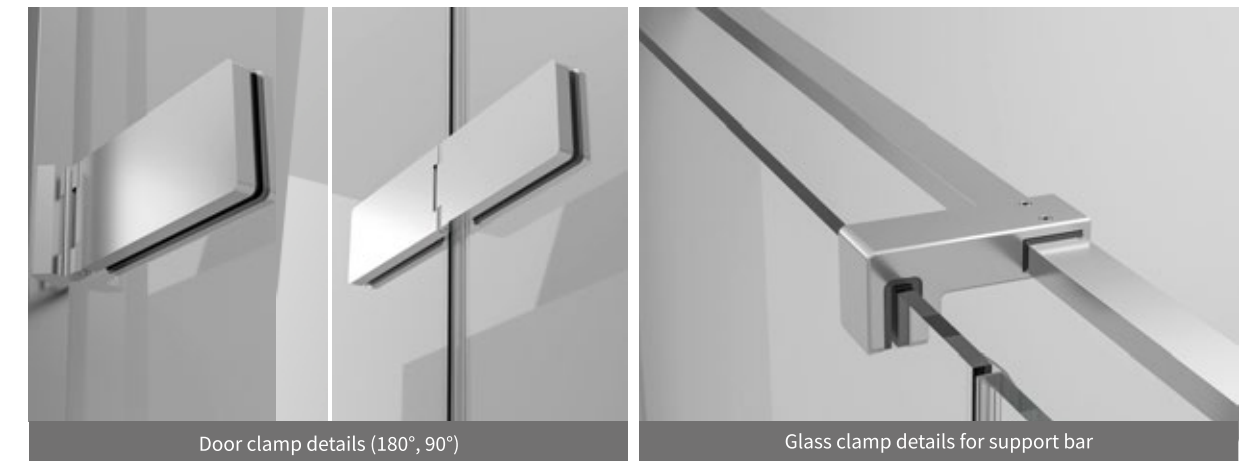
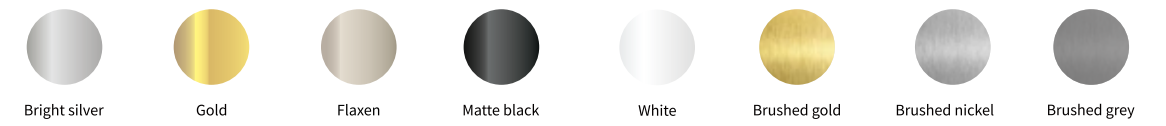

VX-P711

Width B	Product code	Adjustment min-max B	Door opening C
700	VX-P711-A	685-700	605
760	VX-P711-B	745-760	665
800	VX-P711-C	785-800	705
900	VX-P711-D	885-900	805

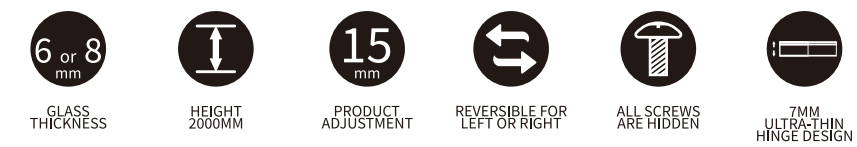
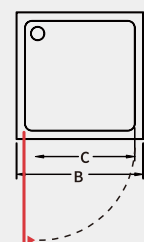

- *Optional configurations:
1. Inward and outward opening design with internal flat structure.
 2. Automatic lift and drainage system for the door bottom.
 3. Support bar options (diagonal support bar, straight support bar).

*Other handles are available. For more information, please see page 13.



VX-P721

Width B	Product code	Adjustment min-max B	Door opening C
900	VX-P721-A	885-900	615
1000	VX-P721-B	985-1000	615
1100	VX-P721-C	1085-1100	615
1200	VX-P721-D	1185-1200	615
1400	VX-P721-E	1385-1400	615

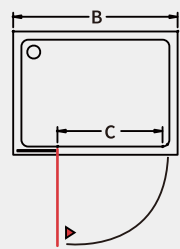

VX-SP

Width B	Product code	Adjustment min-max B
700	VX-SP-A	670-690
760	VX-SP-B	730-750
800	VX-SP-C	770-790
900	VX-SP-D	870-890

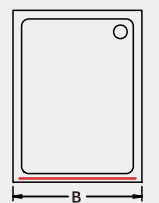



FRAME MATERIAL: Stainless steel frame

FRAME COLORS

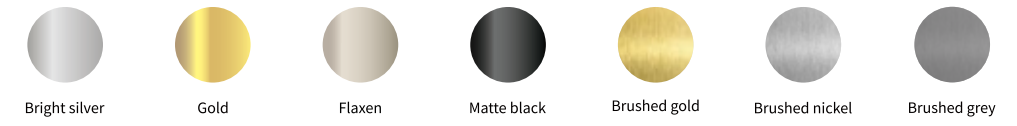

FT-P711

Width B	Product code	Adjustment min-max B	Door opening C
700	P711-A	680-690	598
760	P711-B	740-750	658
800	P711-C	780-790	698
900	P711-D	880-890	798

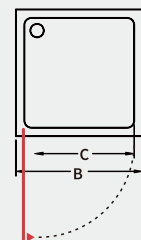

- 

10
mm
GLASS THICKNESS
- 

2000
mm
HEIGHT
- 

15
mm
PRODUCT ADJUSTMENT
- 

REVERSIBLE FOR LEFT OR RIGHT
- 

ALL SCREWS ARE HIDDEN

*Other handles are available. For more information, please see page 13.



FT-P721

Width B	Product code	Adjustment min-max B	Door opening C
900	P721-A	885-900	588
1000	P721-B	985-1000	688
1100	P721-C	1085-1100	688
1200	P721-D	1185-1200	688
1400	P721-E	1385-1400	688
1500	P721-F	1485-1500	688
1600	P721-G	1585-1600	688
1700	P721-H	1685-1700	688

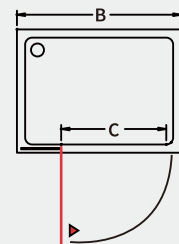

FT-SP

Width B	Product code	Adjustment min-max B	Door opening C
700	SP-A	680-695	
760	SP-B	740-755	
800	SP-C	780-795	
900	SP-D	980-995	

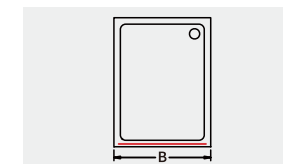

Bottom door system



FT-P331

Width B	Product code	Adjustment min-max B	Door opening C
800	P331-A	785-800	558
900	P331-B	885-900	558
1000	P331-C	985-1000	558
1000	P331-D	1085-1100	558
1200	P331-E	1185-1200	558

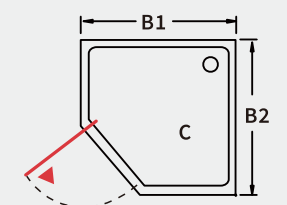

DETAILS

BY-Series



KNURLED HANDLE

NEW

Aluminium
Frame

FRAME COLORS

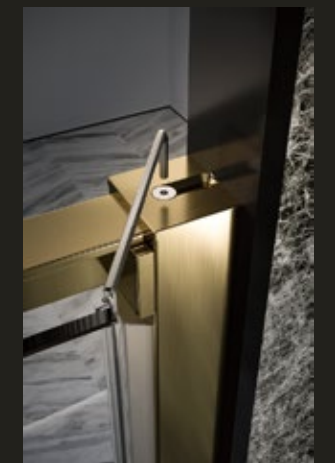

PROFILE ADJUSTMENT
DETAILS

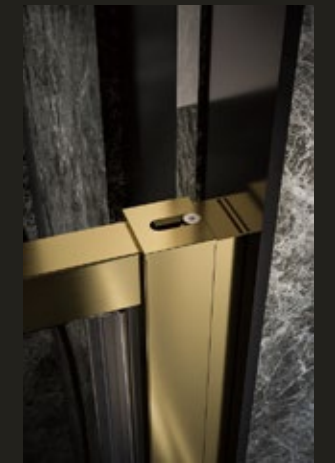

PROFILE DETAILS IN
CLOSING POSITION

8mm GLASS THICKNESS	↔ REVERSIBLE FOR LEFT OR RIGHT HANDED INSTALLATION	↑ HEIGHT 2000mm	PROFILE ALUMINIUM	MAGNETIC CLOSURE
15mm ALUMINIUM PRODUCT ADJUSTMENT	OR	20mm ALUMINIUM PRODUCT ADJUSTMENT		

BY-SERIES

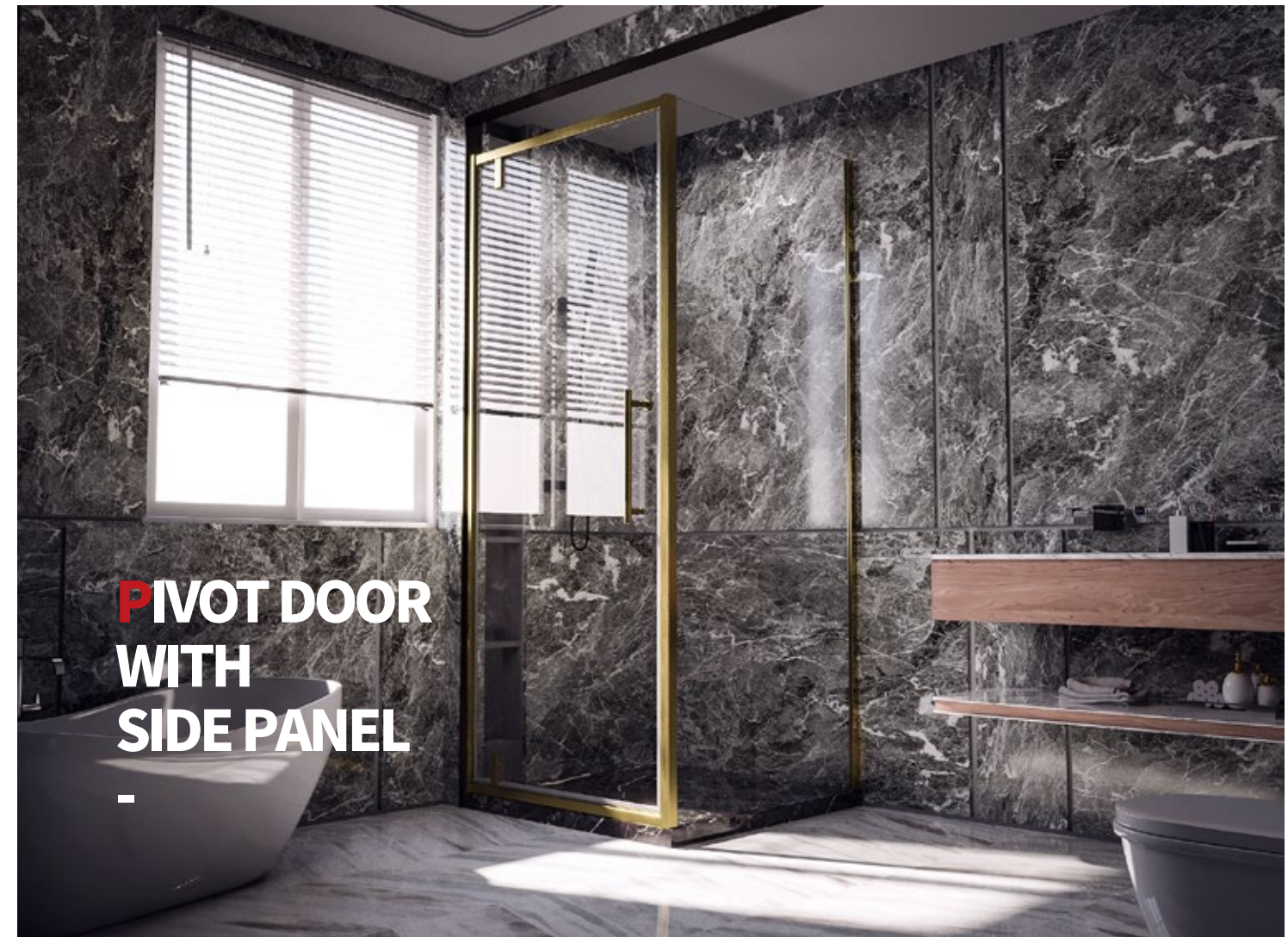

SUS304
PIVOT

SPECIFICATIONS			
Width	Product code	Adjustment B	Door opening
800	BY-P711-A-A	750-790	540
900	BY-P711-A-B	850-890	615
1000	BY-P711-A-C	950-990	715

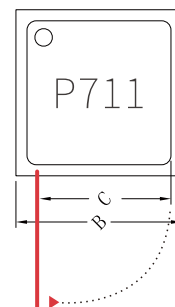

CONNECTION
DETAILS OF
SIDE PANEL

SPECIFICATIONS		
Width B/D	Product code	Adjustment B/D
800/800	BY-P121-A-A	770-790/760-780
900/900	BY-P121-A-B	870-890/860-880
1000/1000	BY-P121-A-C	970-990/960-980

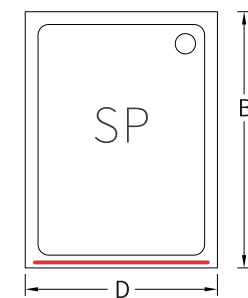



HINGE DOOR

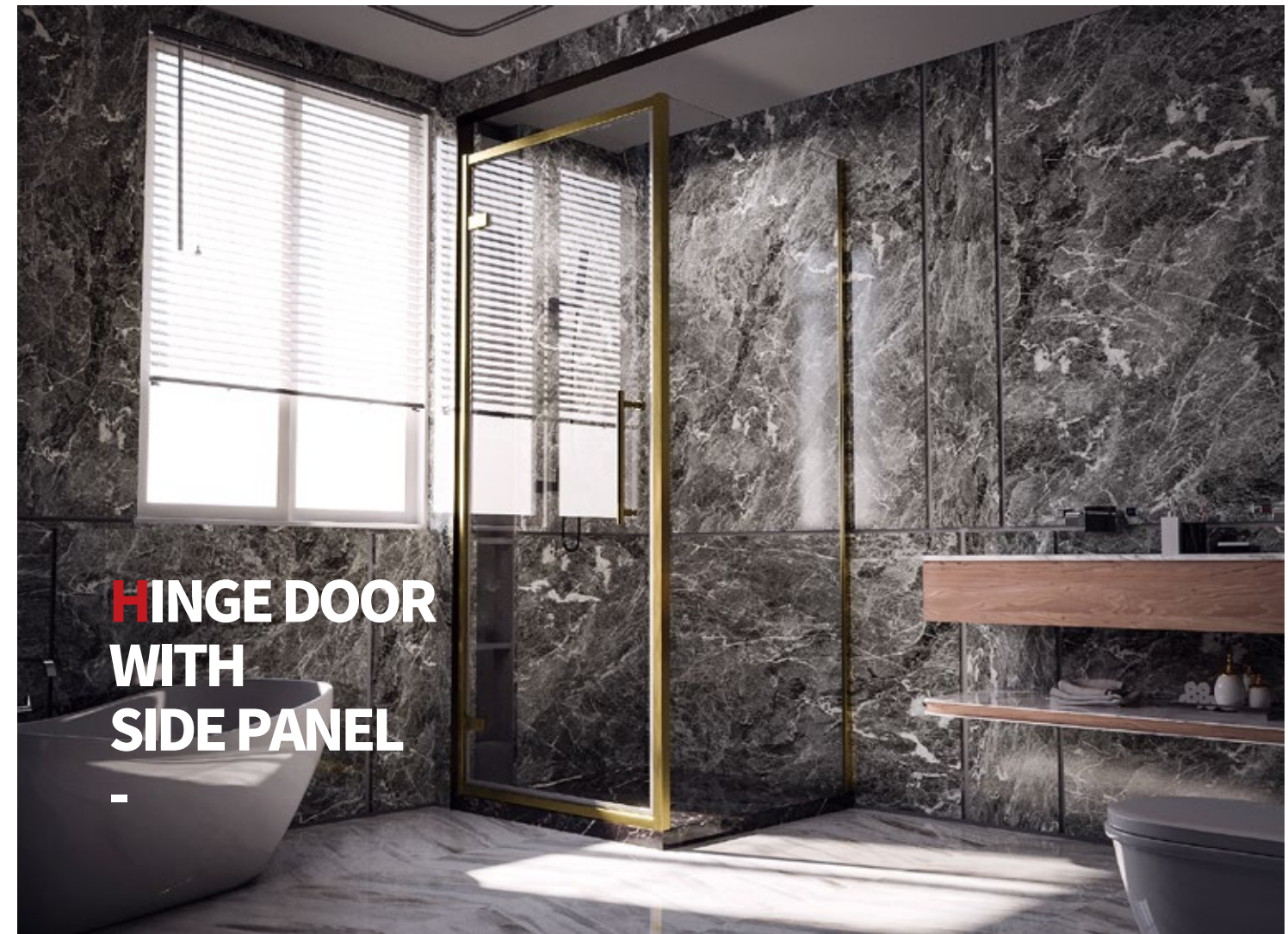

HINGE DOOR WITH SIDE PANEL



SUS304
HINGE

SPECIFICATIONS			
Width	Product code	Adjustment B	Door opening
800	BY-P711-B-A	750-790	640
900	BY-P711-B-B	850-890	740
1000	BY-P711-B-C	950-990	840

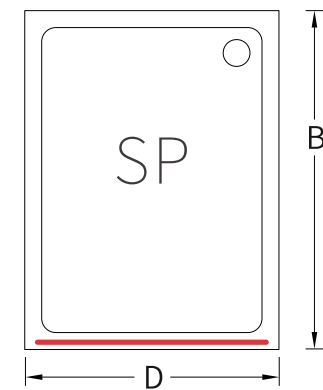
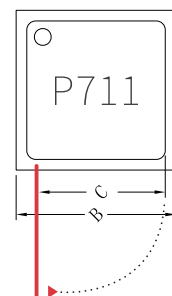

SPECIFICATIONS		
Width B/D	Product code	Adjustment B/D
800/800	BY-P121-B-A	770-790/760-780
900/900	BY-P121-B-B	870-890/860-880
1000/1000	BY-P121-B-C	970-990/960-980



TOP DETAILS



CONNECTION DETAILS OF SIDE PANEL

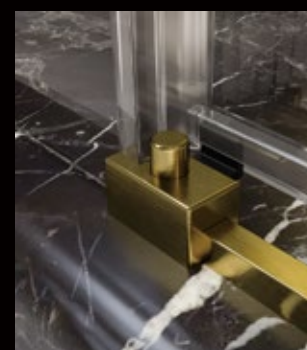

QUICK RELEASE GUIDE BLOCK

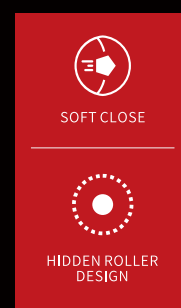
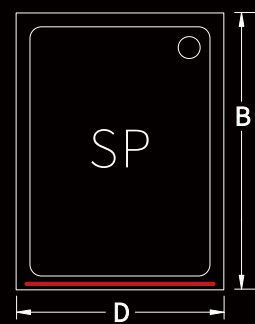

SPECIFICATIONS		
Width B/D	Product code	Adjustment B/D
1200/800	BY-S131-A-A	1170-1190/760-780
1400/900	BY-S131-A-B	1370-1390/860-880
1500/1000	BY-S131-A-C	1470-1490/960-980

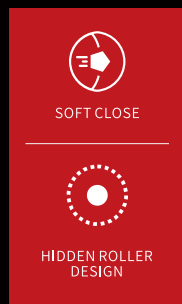
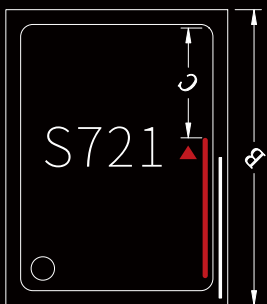

SPECIFICATIONS			
Width	Product code	Adjustment B	Door opening
1200	BY-S721-A-A	1150-1190	490
1400	BY-S721-A-B	1350-1390	590
1500	BY-S721-A-C	1450-1490	640



INFOLD DOOR

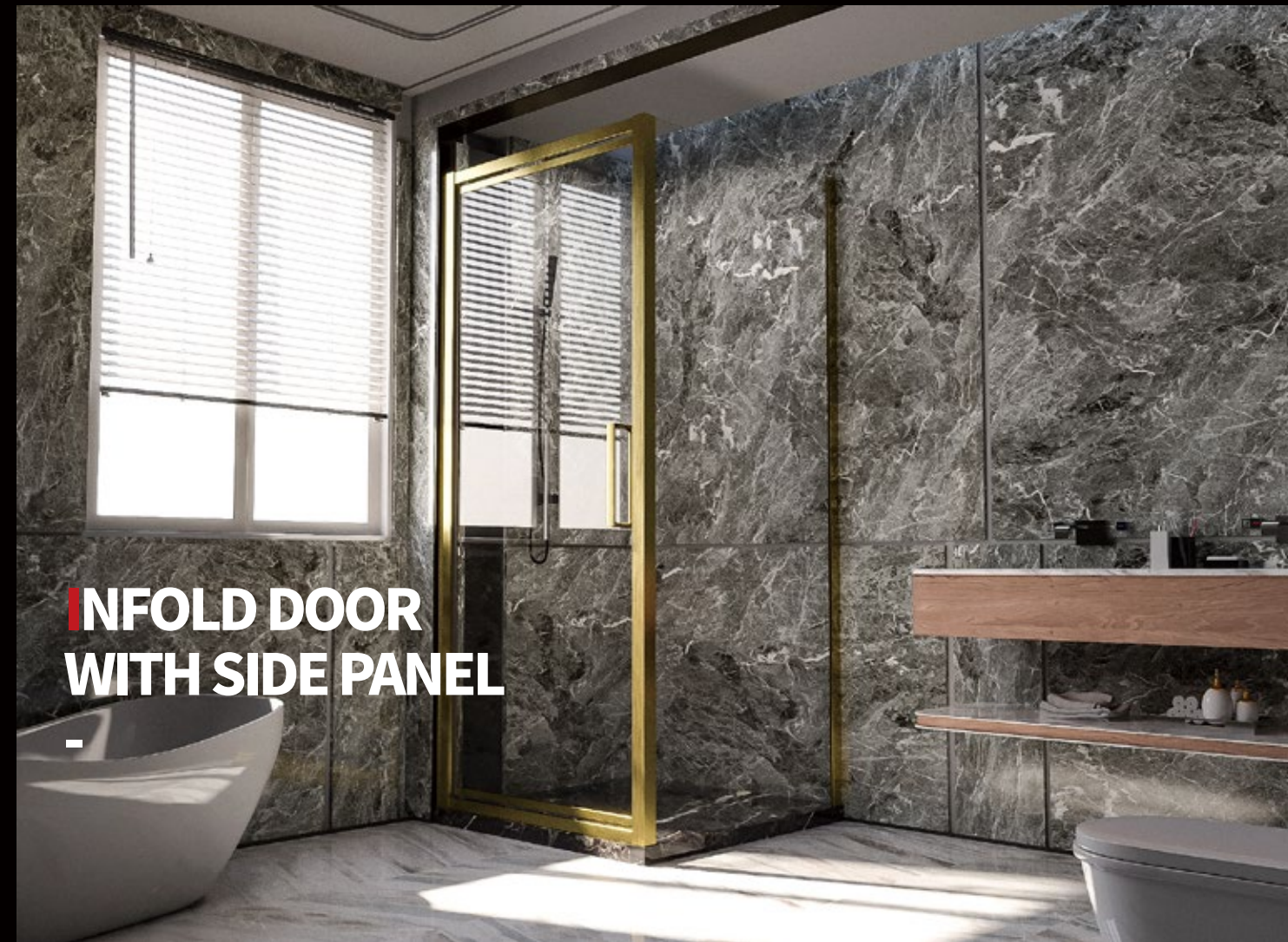

INFOLD DOOR WITH SIDE PANEL



TOP DETAILS



SUS304 HINGE



BALL CATCH

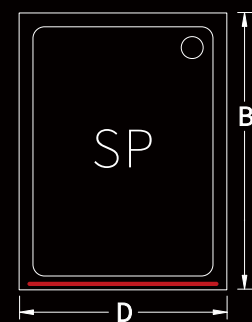

SPECIFICATIONS

Width B/D	Product code	Adjustment B/D
800/800	BY-B121-A	770-790/760-780
900/900	BY-B121-B	870-890/860-880
1000/1000	BY-B121-C	970-990/960-980



SPECIFICATIONS

Width	Product code	Adjustment B	Door opening
800	BY-B711-A	750-790	620
900	BY-B711-B	850-890	720
1000	BY-B711-C	950-990	820



ONE DOOR SLIDER



ONE DOOR SLIDER WITH SIDE PANEL



BOTTOM ROLLER DETAILS

-

SPECIFICATIONS			
Width	Product code	Adjustment B	Door opening
1200	BY-S721-C-A	1150-1190	490
1400	BY-S721-C-B	1350-1390	590
1500	BY-S721-C-C	1450-1490	640

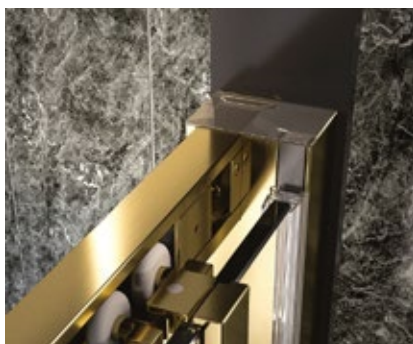

TOP RAIL DETAILS IN CLOSING POSITION

-

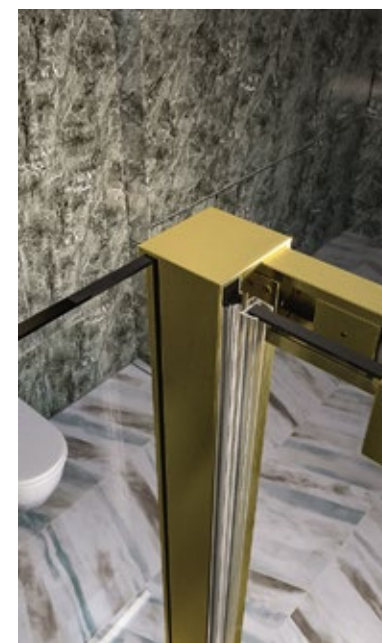
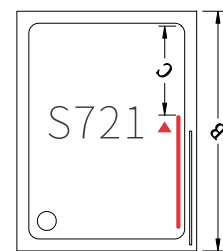

CONNECTION DETAILS OF SIDE PANEL

-

SPECIFICATIONS		
Width B/D	Product code	Adjustment B/D
800	BY-S131-A	1170-1190/760-780
900	BY-S131-B	1370-1390/860-880

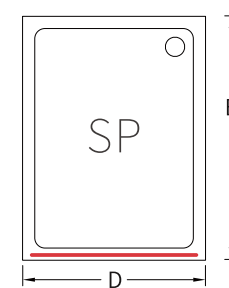

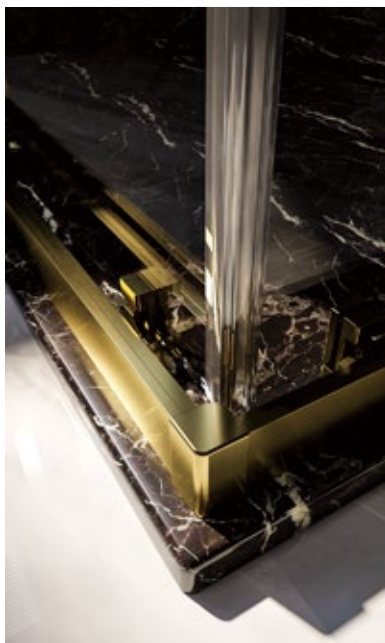
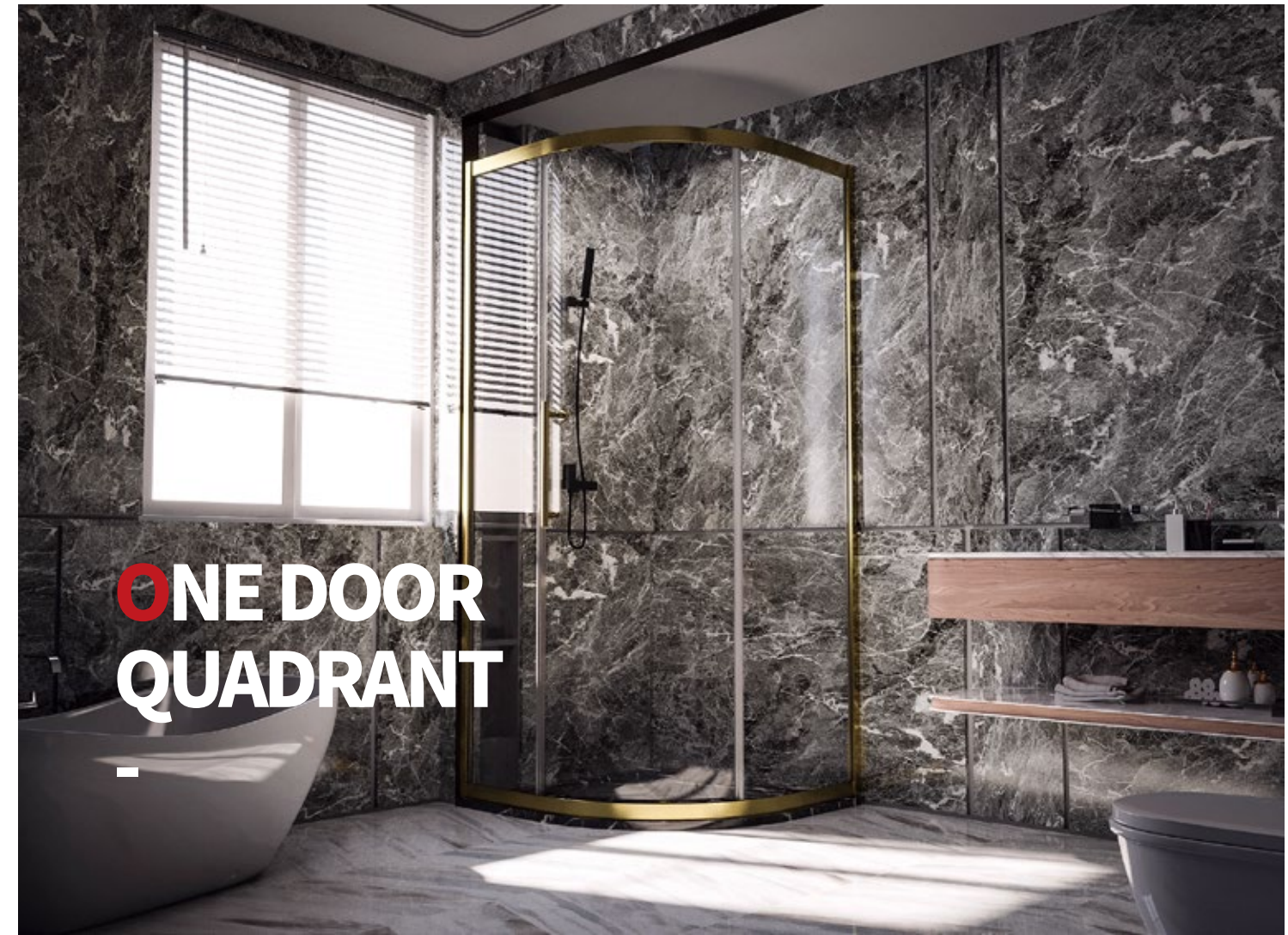
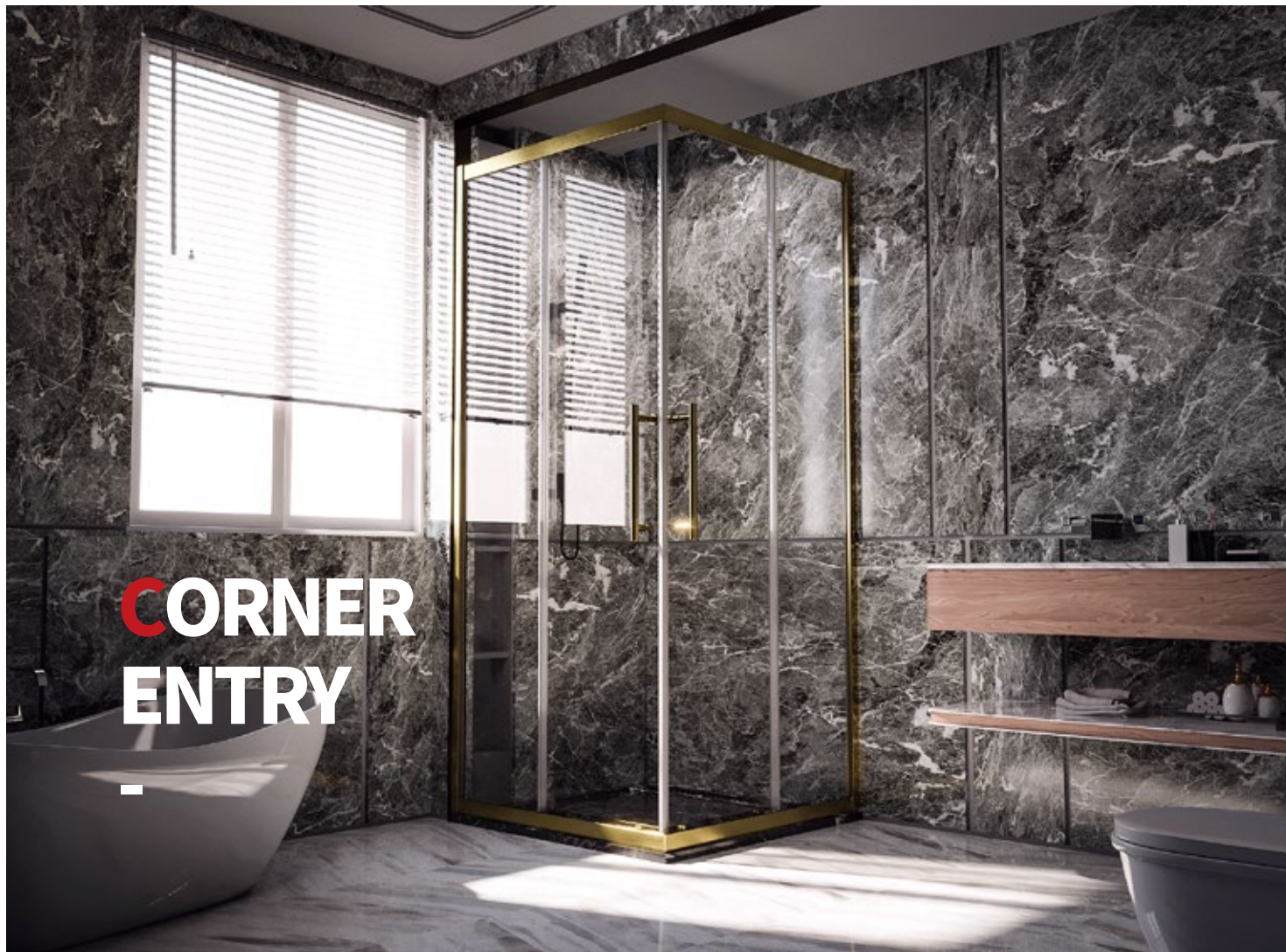

CORNER
DETAILS

SPECIFICATIONS			
Width B/D	Product code	Adjustment B1/B2	Door opening
800	BY-S142-A	760-780/760-780	430
900	BY-S142-B	860-880/860-880	500
1000	BY-S142-C	960-980/960-980	570

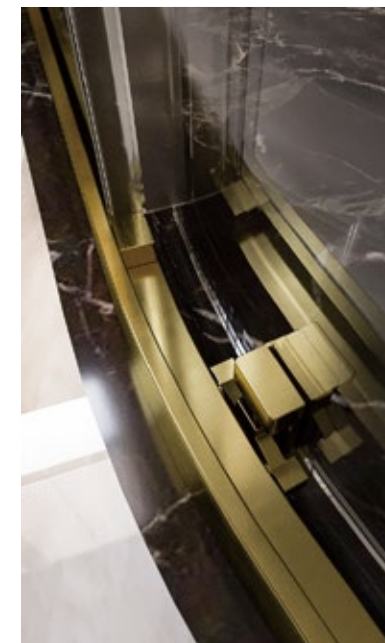
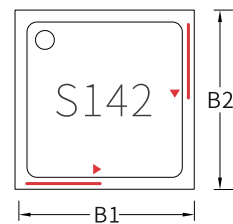

BOTTOM
RAIL
DETAILS

SPECIFICATIONS			
Width B/D	Product code	Adjustment B1/B2	Door opening
800	BY-S431-A	760-780/760-780	450
900	BY-S431-B	860-880/860-880	500
1000	BY-S431-C	960-980/960-980	500

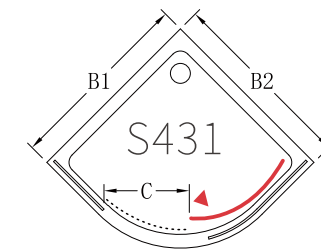



TWO-DOOR QUADRANT

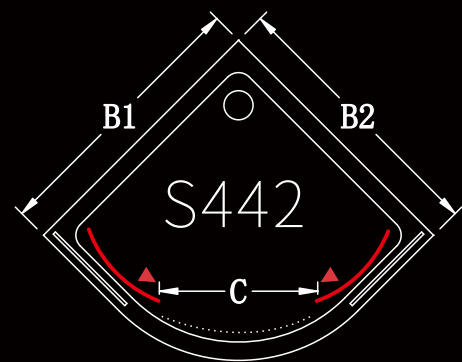

SPECIFICATIONS			
Width B/D	Product code	Adjustment B1/B2	Door opening
800	BY-S442-A	760-780/760-780	470
900	BY-S442-B	860-880/860-880	540
1000	BY-S442-C	960-980/960-980	540

WALK IN

Series

ROSERY SHOWER DOOR

|||

8mm
GLASS
THICKNESS

or

10mm
GLASS
THICKNESS

HEIGHT
2000mm

15mm
PRODUCT
ADJUSTMENT

REVERSIBLE FOR
LEFT OR RIGHT
HANDED
INSTALLATION

304 STAINLES
STEEL



Polished



Brushed gold



Brushed gray



Rose gold



Brushed nickel



WALK IN-A

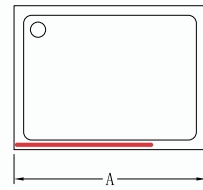

Width	Product code	Adjustment min-max
900	CC-A1	880-900
1000	CC-A2	980-1000
1200	CC-A3	1180-1200
1400	CC-A4	1380-1400

WALK IN-B

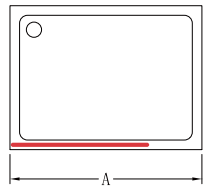

Width	Product code	Adjustment min-max
900	CC-B1	880-900
1000	CC-B2	980-1000
1200	CC-B3	1180-1200
1400	CC-B4	1380-1400

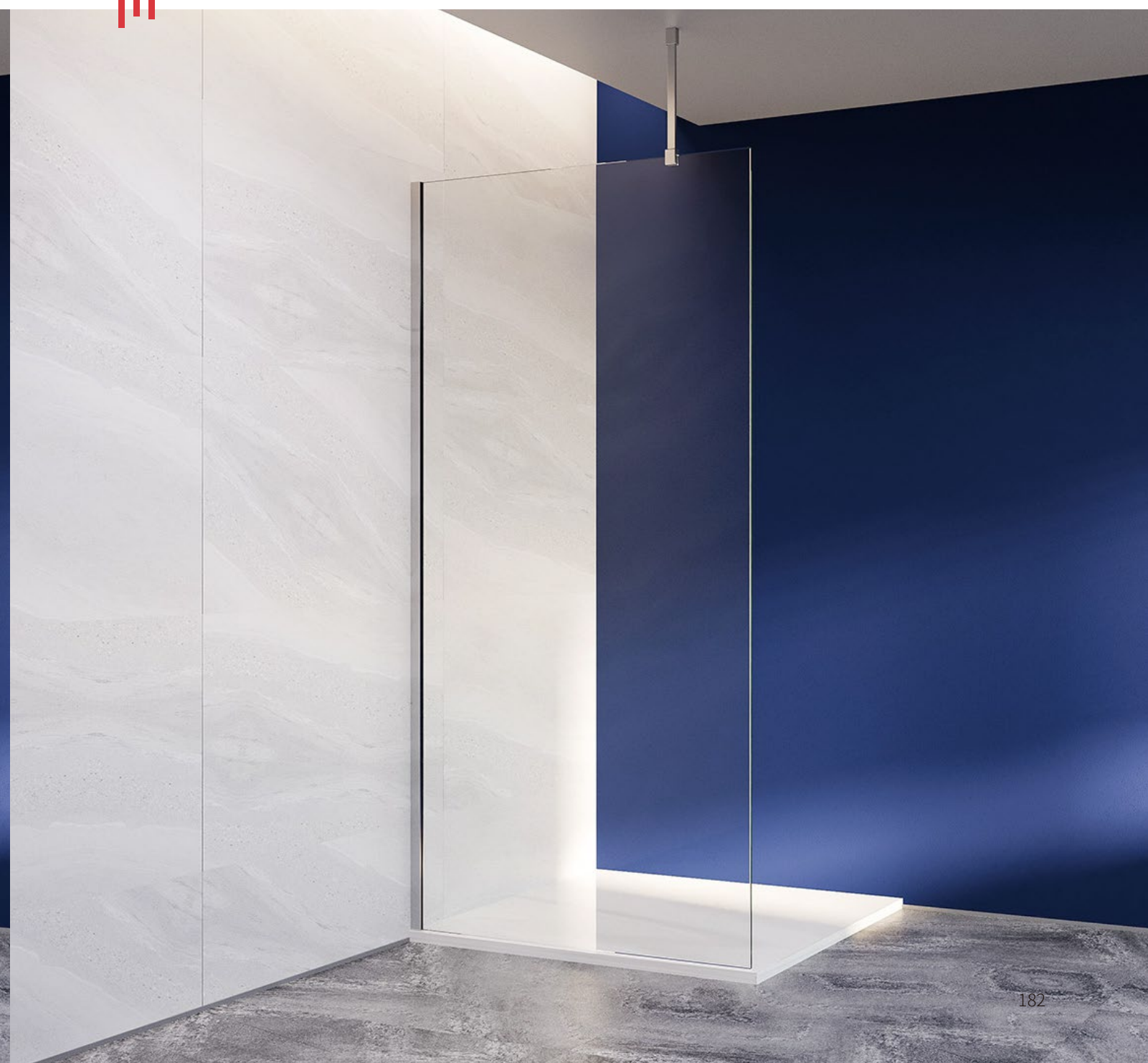
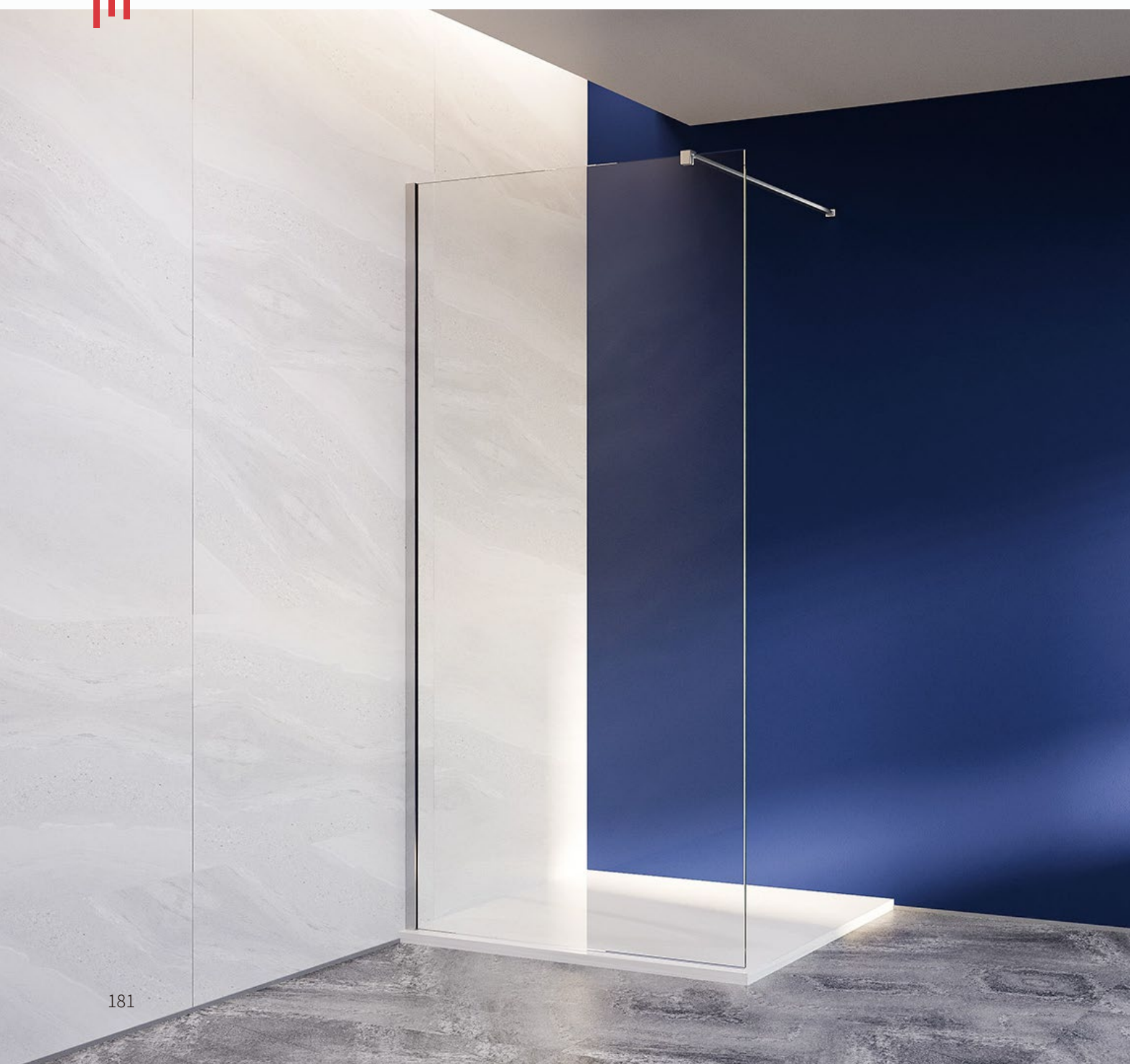



WALK IN-C

Width	Product code	Adjustment min-max
900	CC-C1	880-900
1000	CC-C2	980-1000
1200	CC-C3	1180-1200
1400	CC-C4	1380-1400

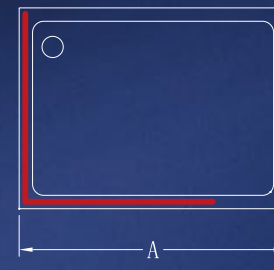

WALK IN-D

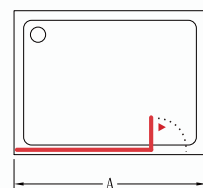

MOVE

Width	Product code	Adjustment min-max
-------	--------------	--------------------

900	CC-D1	880-900
1000	CC-D2	980-1000
1200	CC-D3	1180-1200
1400	CC-D4	1380-1400

WALK IN-E

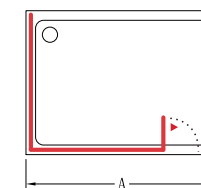

MOVE

Width	Product code	Adjustment min-max
-------	--------------	--------------------

900	CC-E1	880-900
1000	CC-E2	980-1000
1200	CC-E3	1180-1200
1400	CC-E4	1380-1400

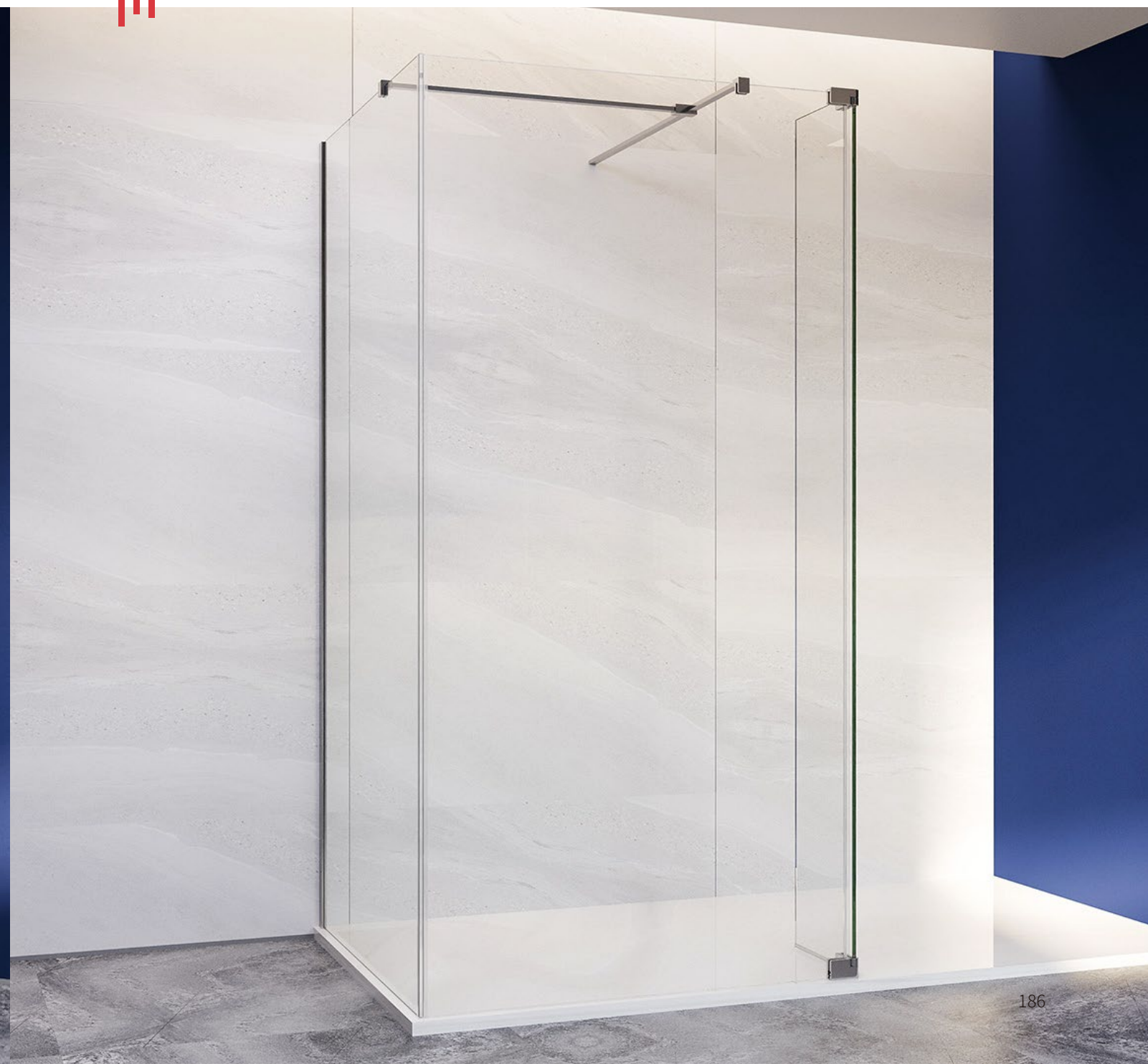
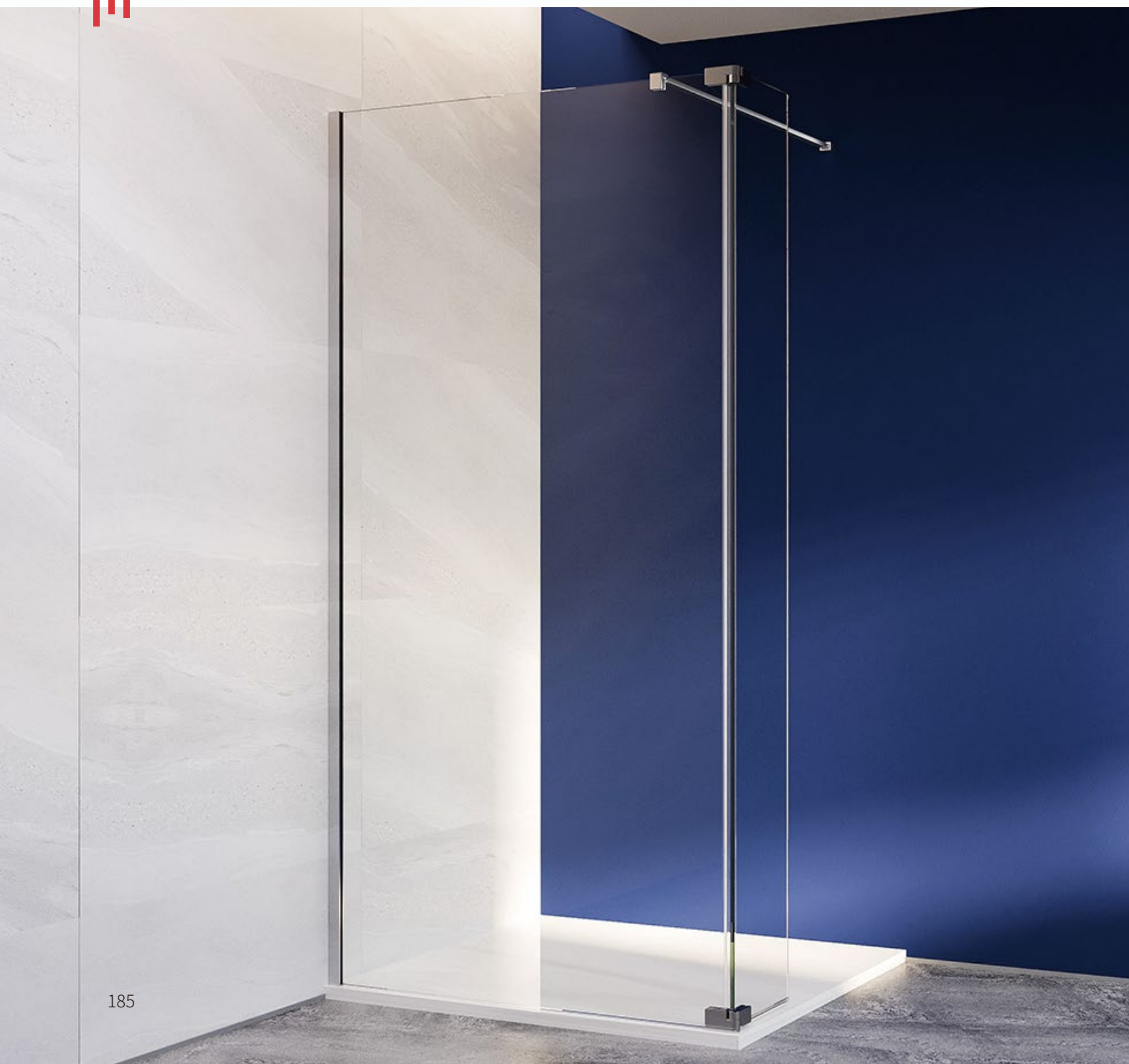

WALK IN-F

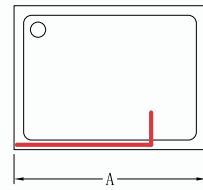

Width Product code Adjustment min-max

900	CC-F1	880-900
1000	CC-F2	980-1000
1200	CC-F3	1180-1200
1400	CC-F4	1380-1400

WALK IN-G

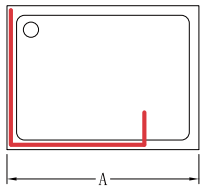

Width Product code Adjustment min-max

900	CC-G1	880-900
1000	CC-G2	980-1000
1200	CC-G3	1180-1200
1400	CC-G4	1380-1400

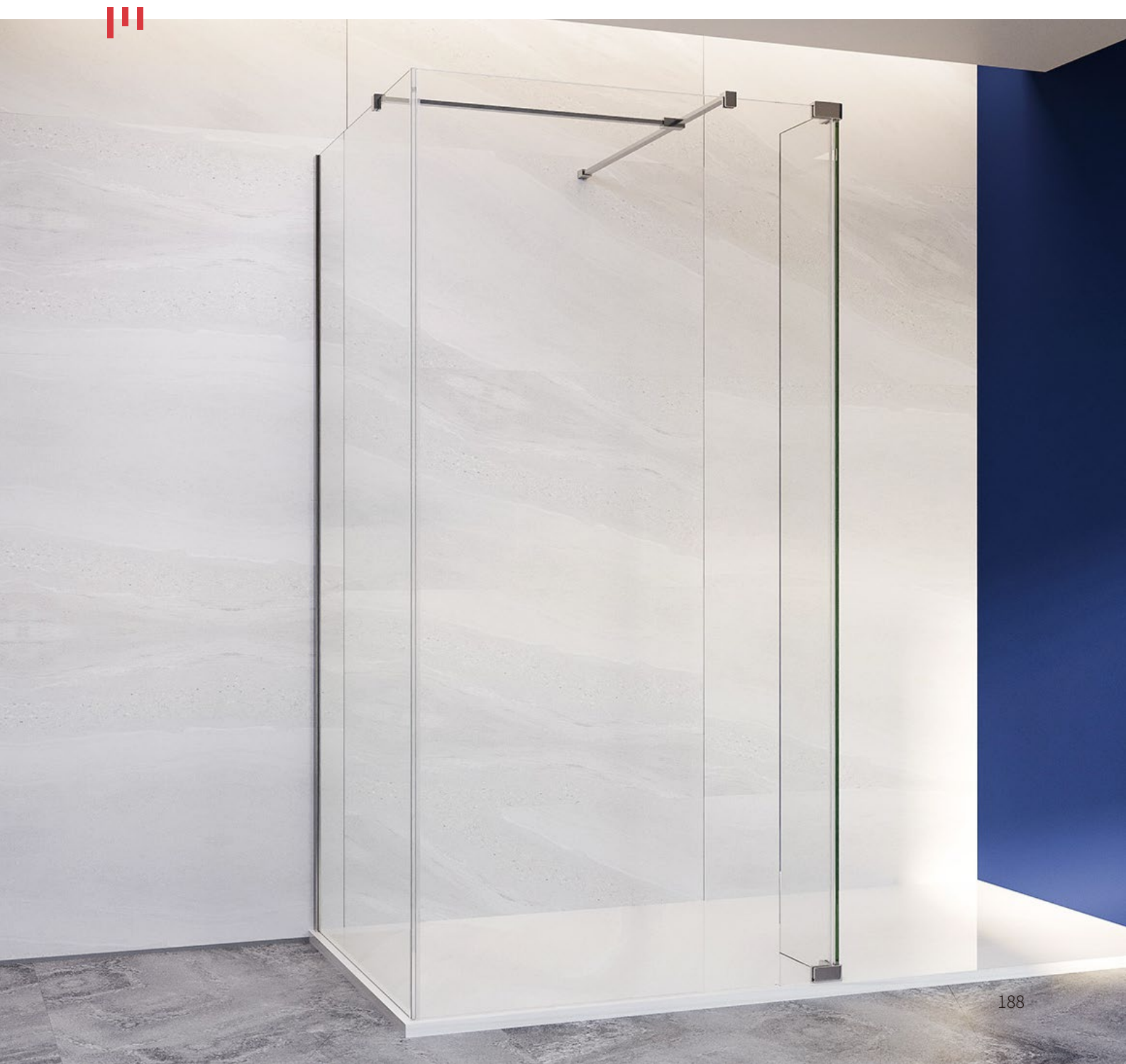



WALK IN-H

Width	Product code	Adjustment min-max
900	CC-H1	880-900
1000	CC-H2	980-1000
1200	CC-H3	1180-1200
1400	CC-H4	1380-1400

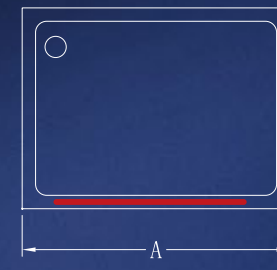

WALK IN-Y

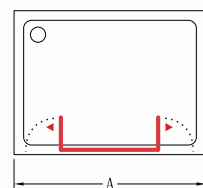

MOVE

Width	Product code	Adjustment min-max
-------	--------------	--------------------

900	CC-Y1	880-900
1000	CC-Y2	980-1000
1200	CC-Y3	1180-1200
1400	CC-Y4	1380-1400

WALK IN-J

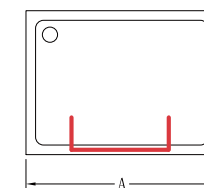

Width	Product code	Adjustment min-max
-------	--------------	--------------------

900	CC-J1	880-900
1000	CC-J2	980-1000
1200	CC-J3	1180-1200
1400	CC-J4	1380-1400

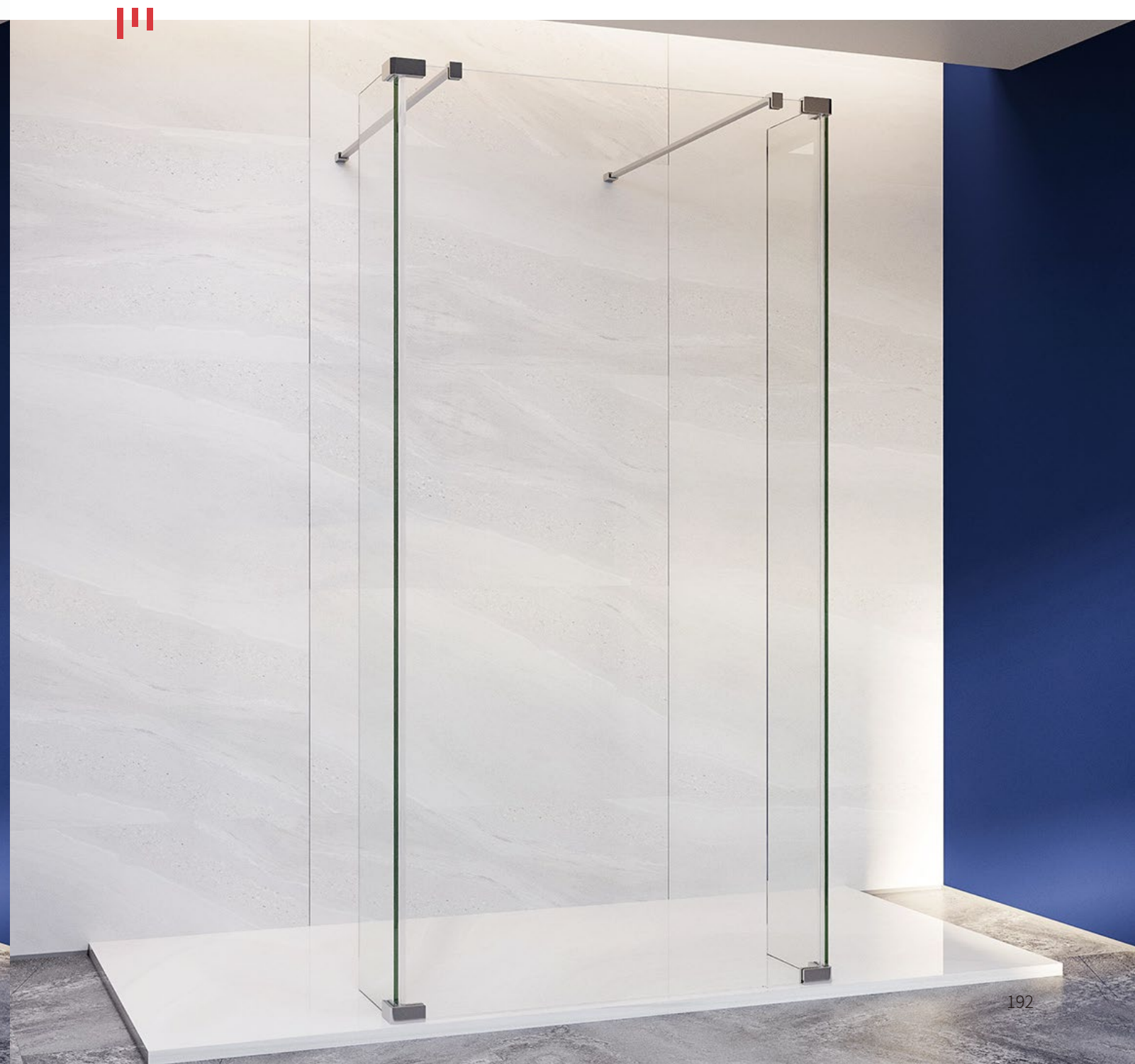
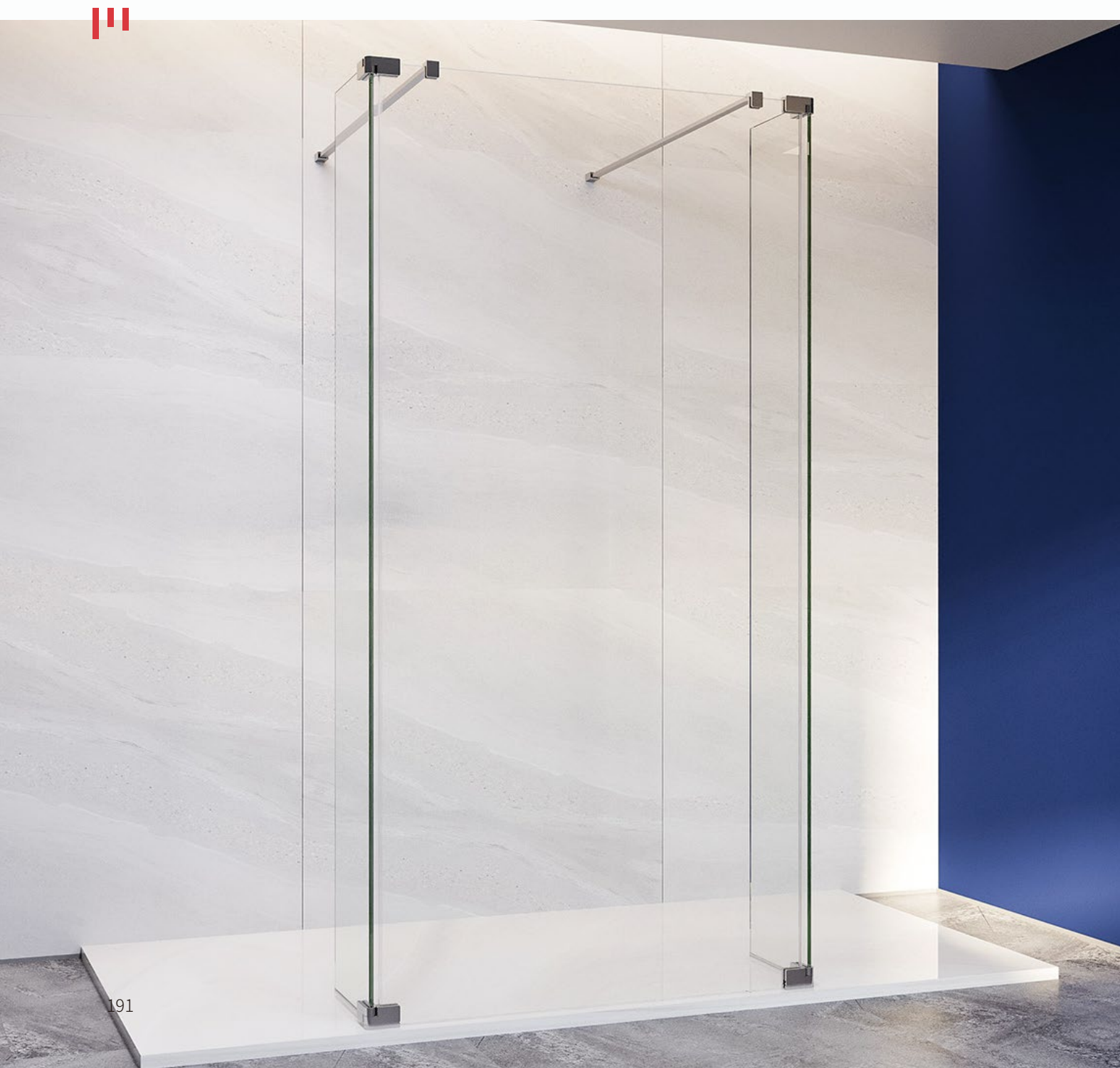



WALK IN-K

Width	Product code	Adjustment min-max
900	CC-K1	880-900
1000	CC-K2	980-1000
1200	CC-K3	1180-1200
1400	CC-K4	1380-1400

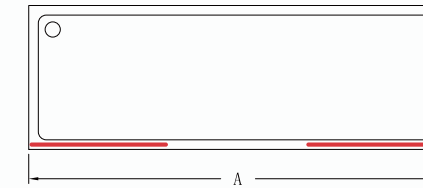

WALK IN-L

Width	Product code	Adjustment min-max
900	CC-L1	880-900
1000	CC-L2	980-1000
1200	CC-L3	1180-1200
1400	CC-L4	1380-1400



WALK IN-M

Width	Product code	Adjustment min-max
900	CC-M1	880-900
1000	CC-M2	980-1000
1200	CC-M3	1180-1200
1400	CC-M4	1380-1400

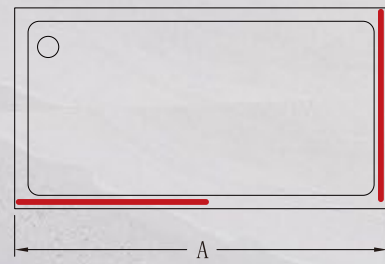

WALK IN-N

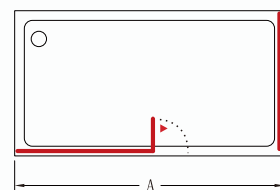

MOVE

Width Product code Adjustment min-max

900	CC-N1	880-900
1000	CC-N2	980-1000
1200	CC-N3	1180-1200
1400	CC-N4	1380-1400

WALK IN-O

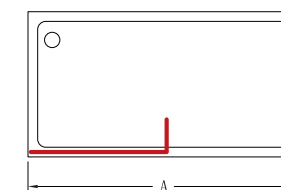

Width Product code Adjustment min-max

900	CC-O1	880-900
1000	CC-O2	980-1000
1200	CC-O3	1180-1200
1400	CC-O4	1380-1400

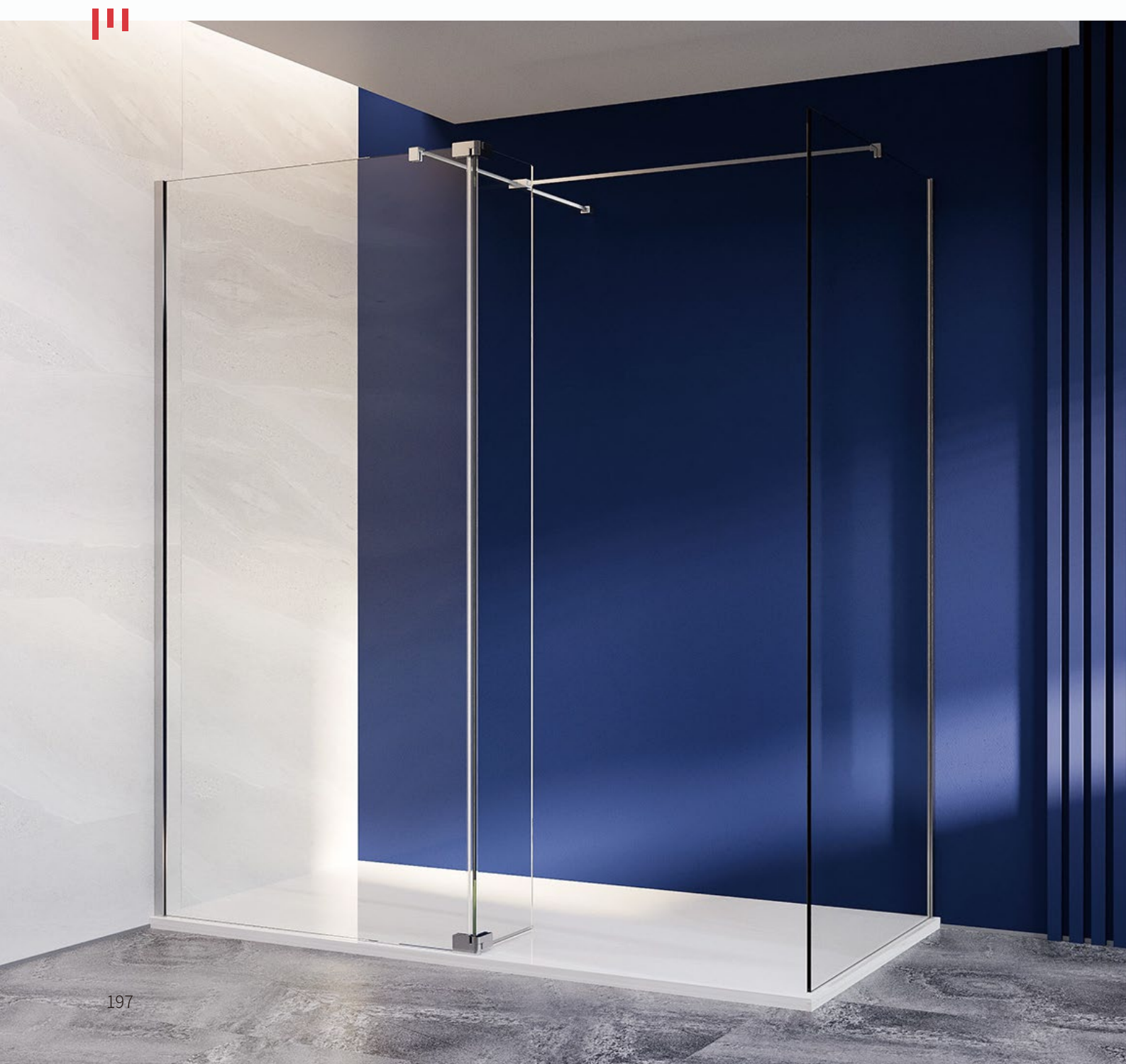

WALK IN-P

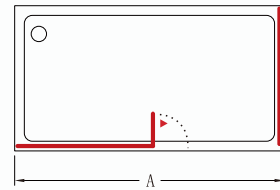

MOVE

Width	Product code	Adjustment min-max
-------	--------------	--------------------

900	CC-P1	880-900
1000	CC-P2	980-1000
1200	CC-P3	1180-1200
1400	CC-P4	1380-1400

WALK IN-Q

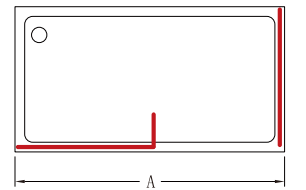

Width	Product code	Adjustment min-max
-------	--------------	--------------------

900	CC-Q1	880-900
1000	CC-Q2	980-1000
1200	CC-Q3	1180-1200
1400	CC-Q4	1380-1400



WALK IN-R

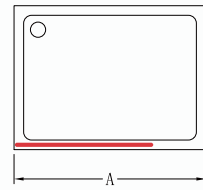

Width	Product code	Adjustment min-max
900	CC-R1	880-900
1000	CC-R2	980-1000
1200	CC-R3	1180-1200
1400	CC-R4	1380-1400

WALK IN-S

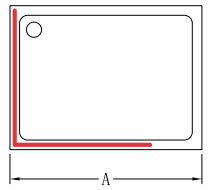

Width	Product code	Adjustment min-max
900	CC-S1	880-900
1000	CC-S2	980-1000
1200	CC-S3	1180-1200
1400	CC-S4	1380-1400

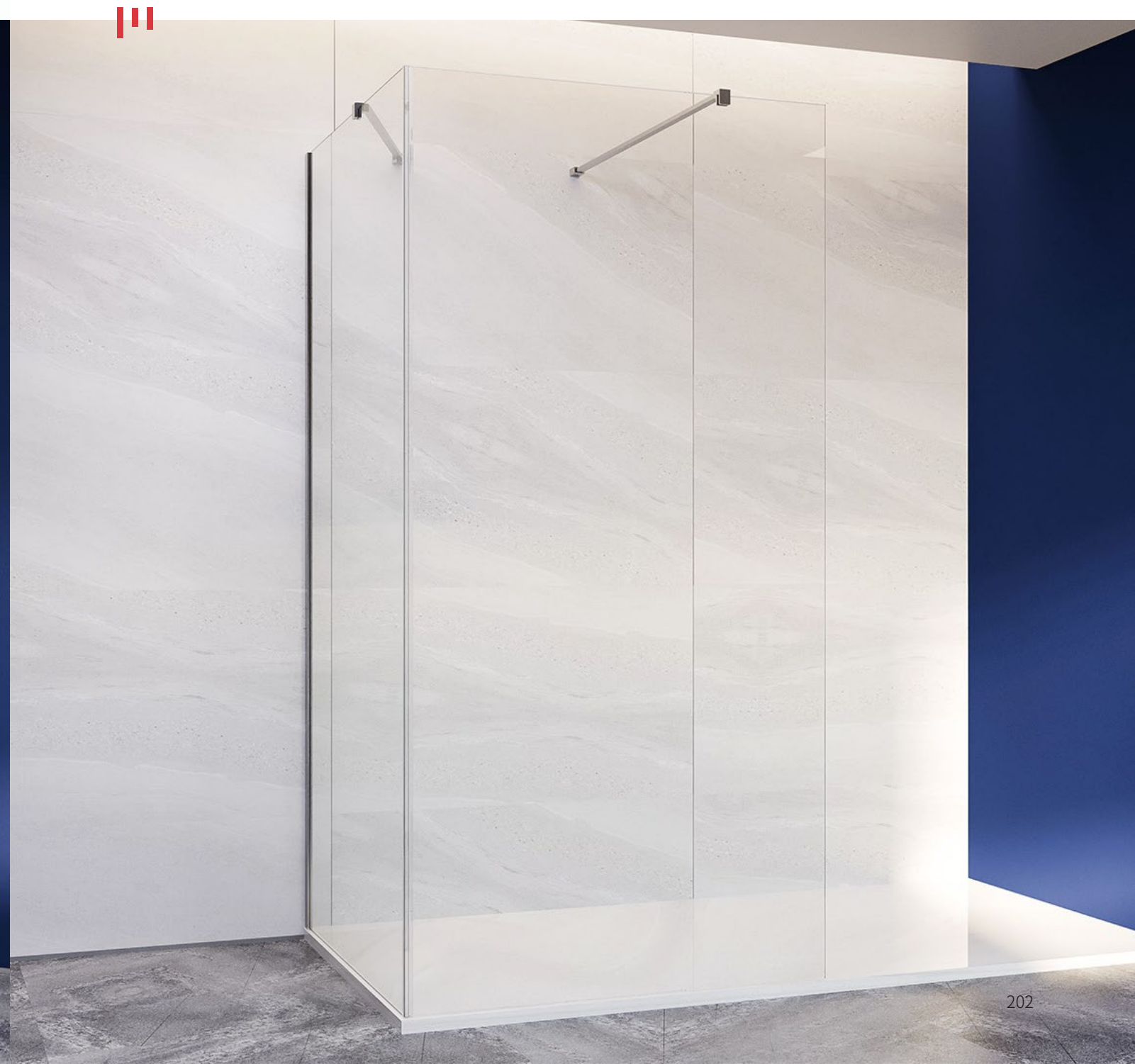
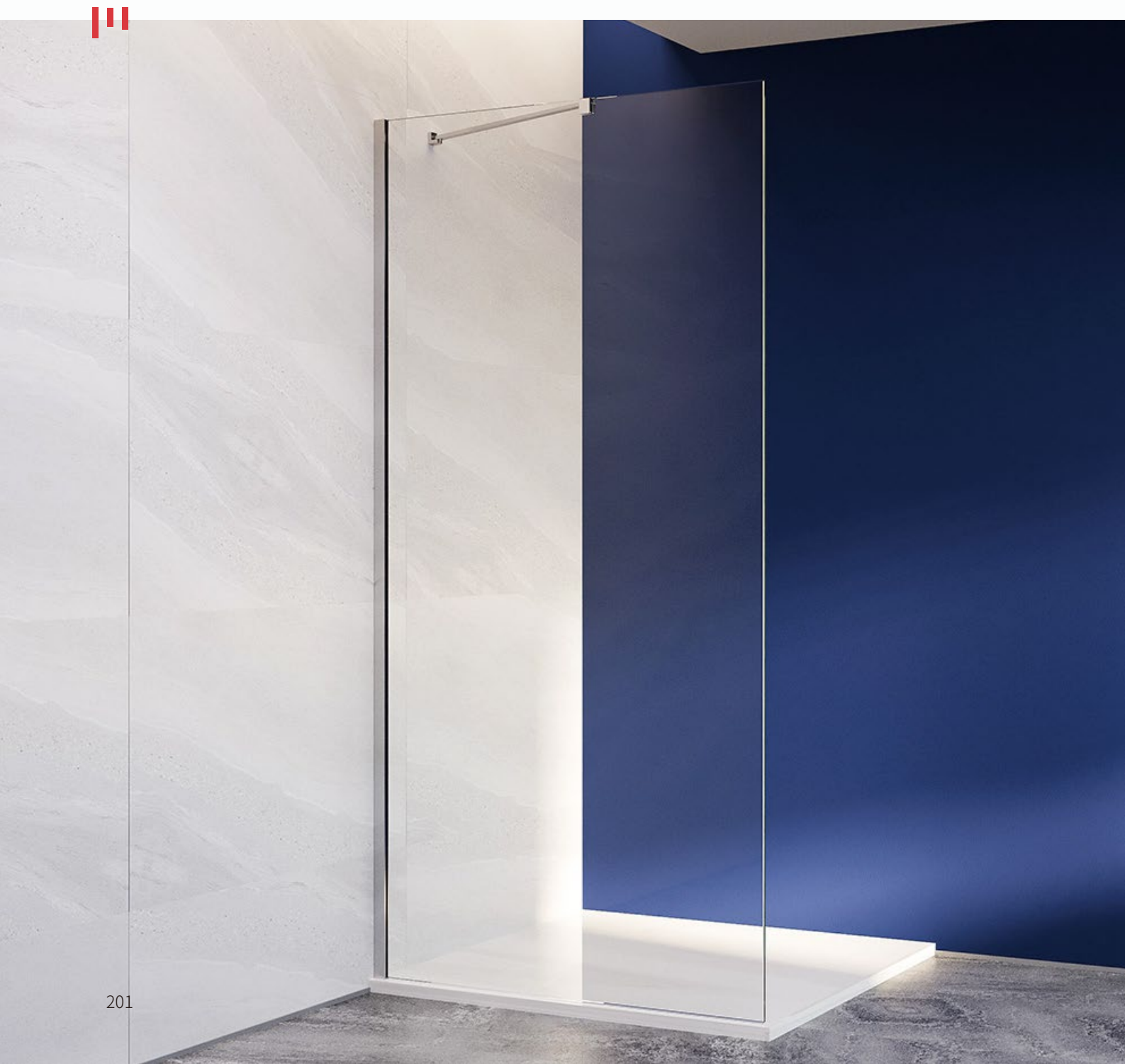

WALK IN-T

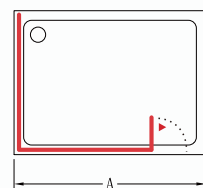

MOVE

Width Product code Adjustment min-max

900	CC-T1	880-900
1000	CC-T2	980-1000
1200	CC-T3	1180-1200
1400	CC-T4	1380-1400

WALK IN-U

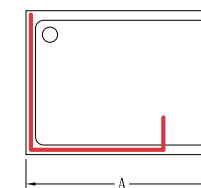

Width Product code Adjustment min-max

900	CC-U1	880-900
1000	CC-U2	980-1000
1200	CC-U3	1180-1200
1400	CC-U4	1380-1400

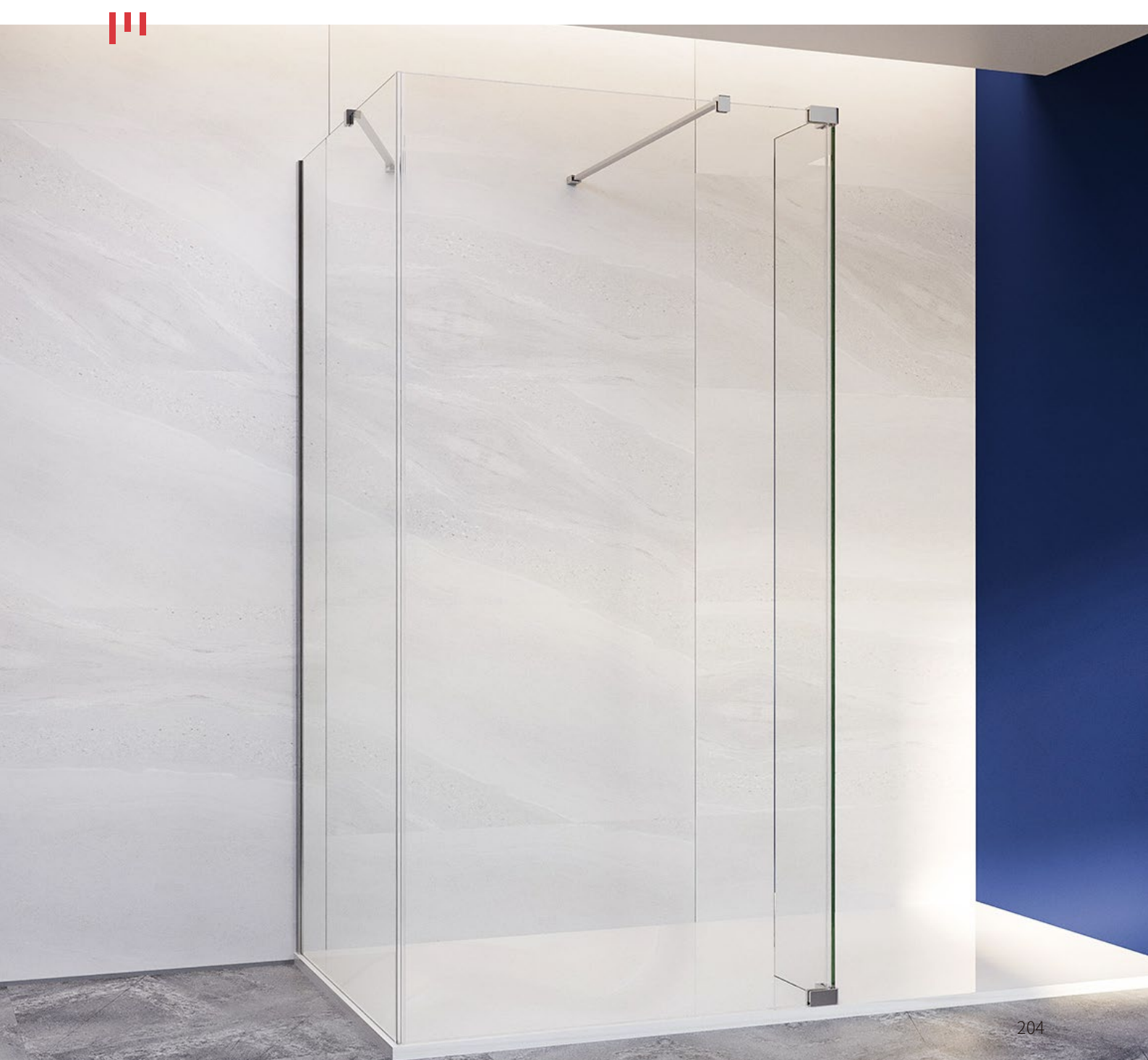
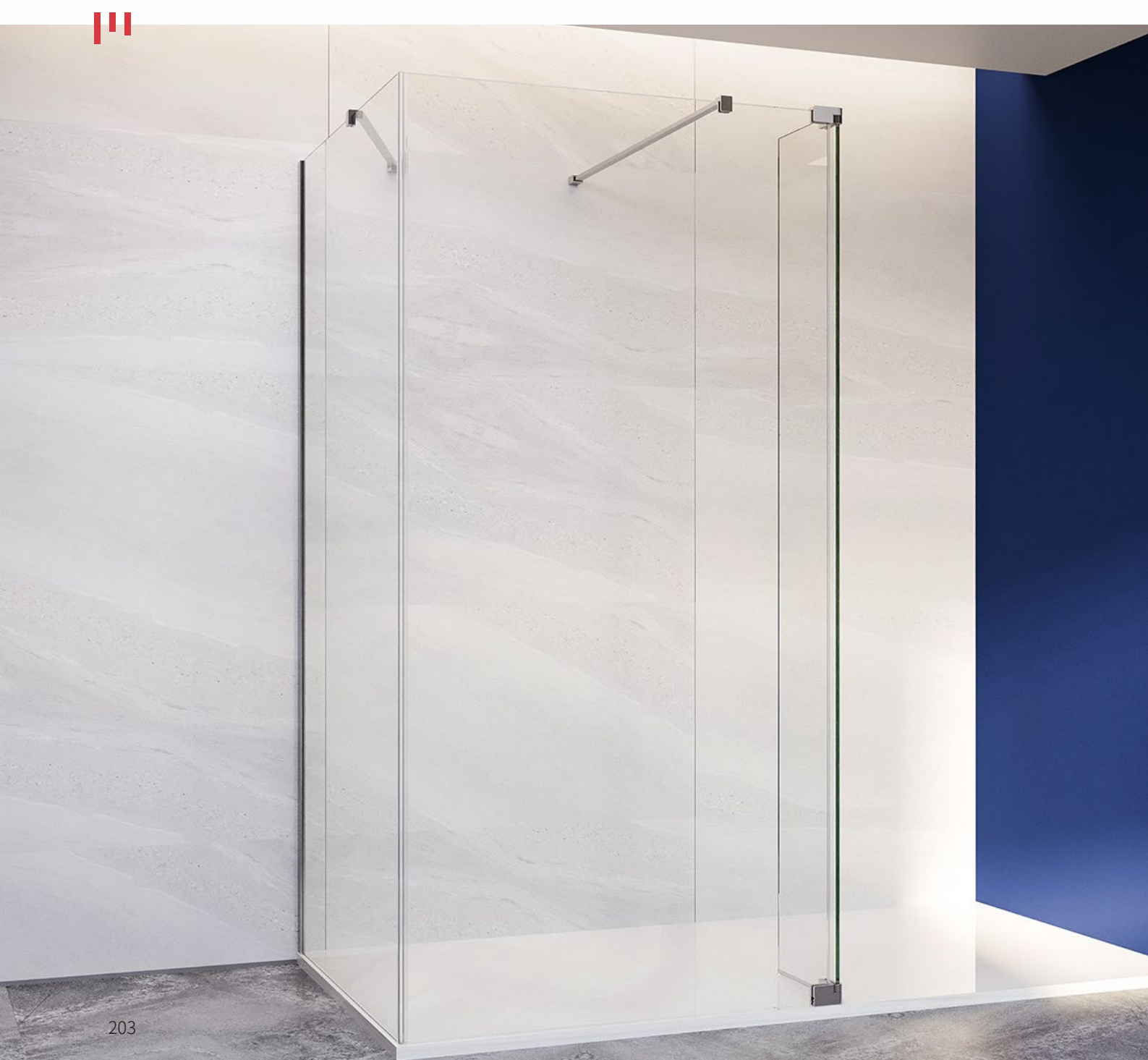



WALK IN-V

Width	Product code	Adjustment min-max
900	CC-V1	880-900
1000	CC-V2	980-1000
1200	CC-V3	1180-1200
1400	CC-V4	1380-1400

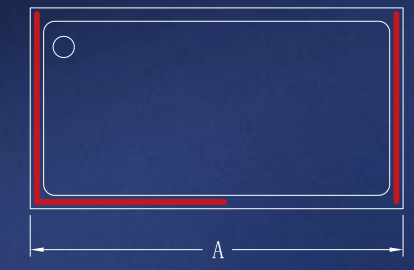

WALK IN-W

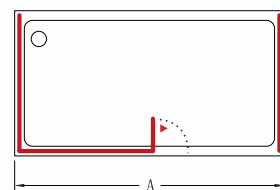

MOVE

Width	Product code	Adjustment min-max
-------	--------------	--------------------

900	CC-W1	880-900
1000	CC-W2	980-1000
1200	CC-W3	1180-1200
1400	CC-W4	1380-1400

WALK IN-X

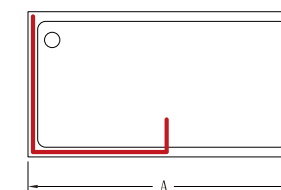

Width	Product code	Adjustment min-max
-------	--------------	--------------------

900	CC-X1	880-900
1000	CC-X2	980-1000
1200	CC-X3	1180-1200
1400	CC-X4	1380-1400

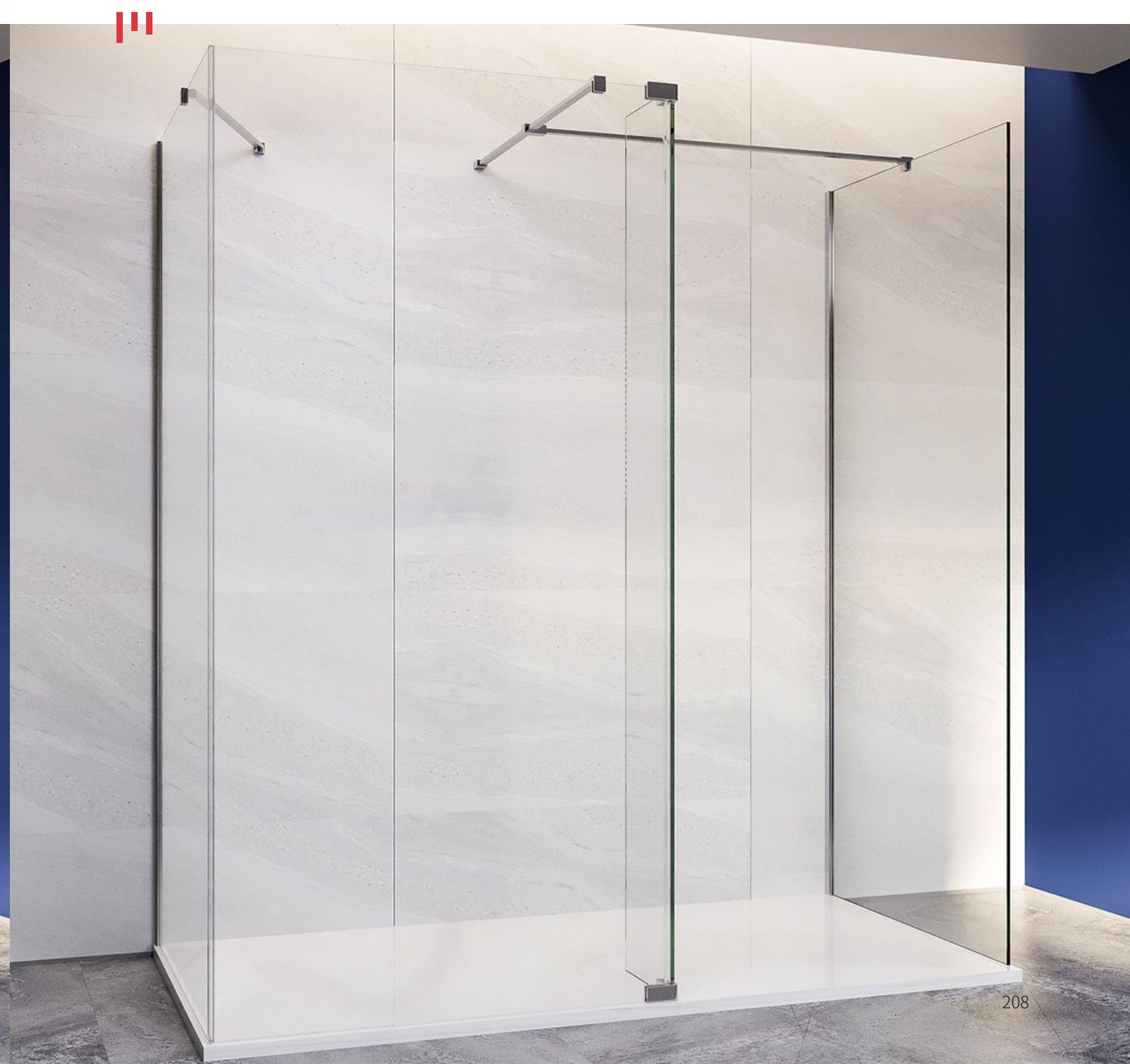
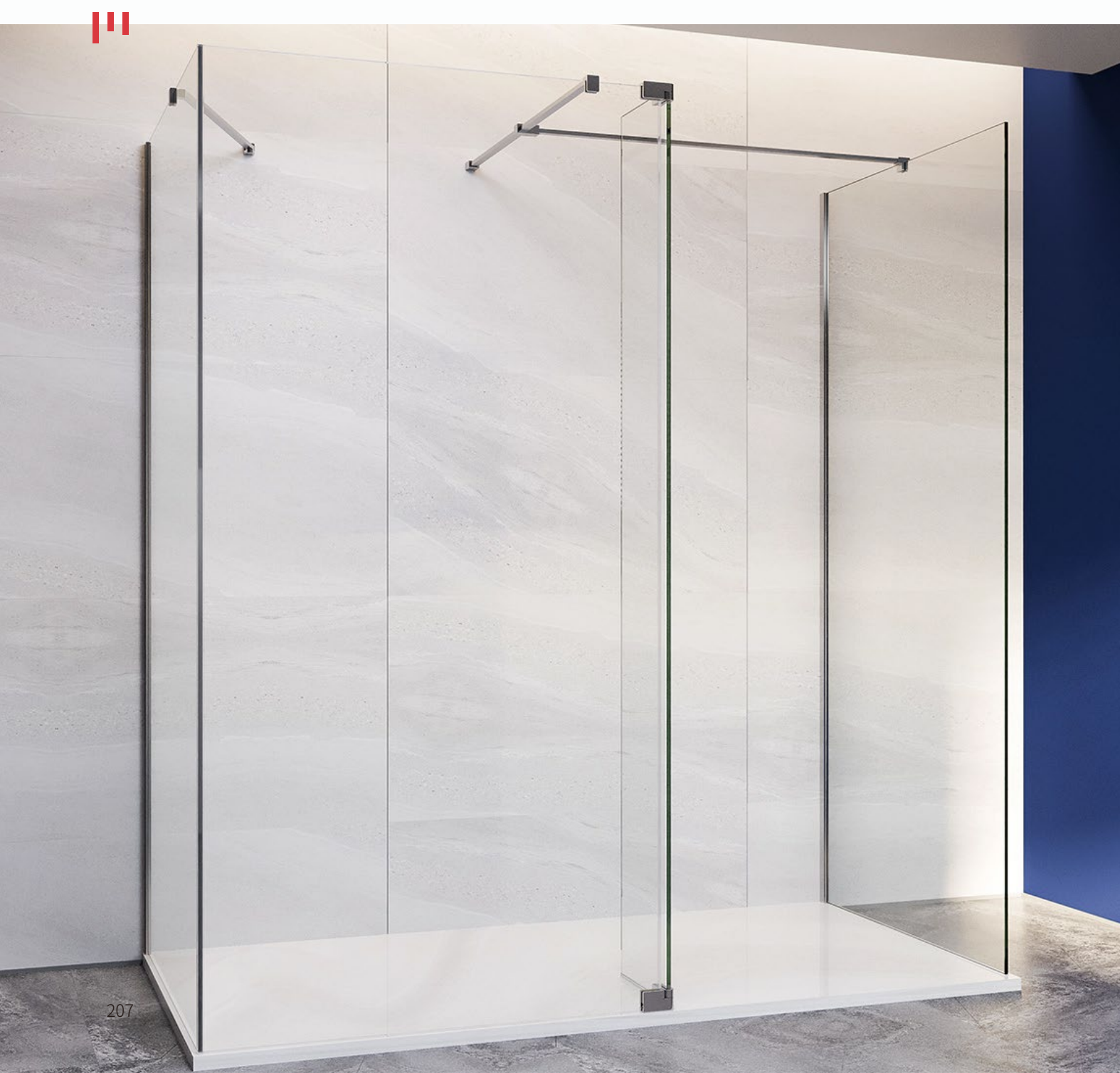

WALK IN-Y

Width	Product code	Adjustment min-max
900	CC-Y1	880-900
1000	CC-Y2	980-1000
1200	CC-Y3	1180-1200
1400	CC-Y4	1380-1400

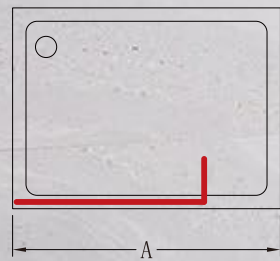

WALK IN-Z

Width	Product code	Adjustment min-max
900	CC-Z1	880-900
1000	CC-Z2	980-1000
1200	CC-Z3	1180-1200
1400	CC-Z4	1380-1400

